



HOME AUTOMATION, INC.



A U T O M A T I O N

Control & Security System

Owner's Manual

**Document Number 20R00-2 Rev. 2.11
January, 2006**

**Copyright © 2001-2006 Home Automation, Inc.
All Rights Reserved**

Contents

INTRODUCTION.....	1
Underwriter's Laboratories (UL) Listing	1
OVERALL DESCRIPTION.....	2
Console Operation	2
Normal Top-Level Display	3
Display Menus	3
Main Menu.....	4
Error Beeps	4
Trouble Beeps	4
Confirmation Beep.....	5
Cancel	5
Time Out.....	5
Areas	5
OmniPro II Maintenance.....	5
SECURITY SYSTEM OPERATION	6
Disarming the Security System and Silencing Alarms	6
Arming the Security System	6
Using Shortcut Keys	7
Quick Arm	8
Bypassing Zones	8
Auto-Bypass	8
Restoring Zones	8
#=GOTO	9
What To Do When You Come Home	9
What Happens When the Alarm is Activated	9
Burglar Alarm Activated	9
Fire Alarm Activated	10
Gas Alarm Activated	10
Emergency Keys	10
Police Emergency	11
Fire Emergency.....	11
Auxiliary Emergency.....	11
Duress Code Entered or Duress Alarm Activated.....	11
Alarm Reset	11
Alarm Cancel	11
Trouble Indications	12
Codes	12
Master Code.....	12
Manager Code.....	13
User Code	13
Duress Code.....	13
Panic Switches	13
Area Arming	13
GOTO Area.....	14
Testing Your System.....	15

CONTROL 16

- Control Commands 16
- About UPB..... 16
- HAI Lighting Control (HLC) Format..... 17
 - About Rooms 17
 - About Room Controllers 17
 - Room Controller LED Indicators..... 17
 - About House Controllers 18
- About CentraLite 18
- About Lutron RadioRA..... 18
- About ALC..... 19
 - ALC Module Types 19
- About X-10 19
- House Codes 19
- Unit Numbers..... 20
- Scrolling Through Names 21
- Controlling Units 21
 - Controlling a Room of HLC Lighting..... 21
 - Configuring Lighting Scenes in an HLC Room..... 21
 - Controlling Individual Lighting Loads in an HLC Room or UPB Units 22
 - Controlling CentraLite Units 22
 - Controlling RadioRA Units 23
 - Controlling ALC or X-10 Units 23
 - Ramp Command (ALC)..... 24
 - Controlling Compose Units 24
 - Scene Command (Compose)..... 24
- Timed Commands..... 25
- Status of a Unit..... 25
- Internal Flags 25
- Controlling Outputs..... 26
- All On / Off..... 26
 - All Lights On 26
 - All Off..... 26
- Leviton Scene Control 27
 - Scene..... 27
 - Scene Commands..... 27
 - Scene Set Command 27
 - Scene On Command 27
 - Scene Off Command..... 28
 - UPB Links..... 28
 - Activating and Deactivating Links..... 28
 - Setting a Link (Lighting Scenes)..... 28
 - Executing Phantom Buttons..... 29
 - Executing CentraLite Scenes 29
- Buttons 30
- Temperature Control 30
- HAI RC-Series Thermostats 31
- Programmable Energy Saver Modules (PESMs) 32
 - Freeze Alarms 34
 - Indoor and Outdoor Temperature..... 34
 - Outdoor Temperature..... 35
 - Temperature Control of Appliances..... 35
- Temperature Alarms 35

Humidity	35
Status.....	36
Configuring HLC Devices	36
Configuring HLC Devices using an Omni Console.....	36
Configuring HLC Devices using an OmniTouch Touchscreen	37
Setup Mode for HLC Devices.....	37
Event Log.....	40
Show Events	40
Messages	41
Record Memo Message	41
Play Memo Message.....	41
Clear Text Messages.....	41
Message	41
Show Message	42
Log Message.....	42
Clear Message.....	42
Say Message	42
Phone Message	42
Send Message (Pro-Link)	43

TELEPHONE CONTROL 44

Telephone Interface	44
In-House Phones	44
Remote Phones	44
Phone Access Denied - Remote Lockout.....	45
Alternate Method	45
Main Menu.....	45
1 - Control.....	46
2 - Security.....	46
GOTO Area	46
3 - Button	46
4 - All.....	46
5 - Temperature.....	46
6 - Status	47
7 - Events	47
8 - Message	48
Playing and Recording a Message	48
Paging and Listening	48
Playing and Recording a Custom Phrase	48
Playing and Recording the Address	49
9 - Good-Bye	49
Panic Button over the Phone (#####)	49
Emergency Dial-Out	50
Digital Dialer	50
Voice Dialer.....	50
How the OmniPro II Voice Dialer Works	50
What the OmniPro II Voice Dialer Does	50
What You Hear - If Your OmniPro II Calls You.....	51
Entering the Code	51

PC Access	51
Built-In Ethernet Port.....	52
Controller IP Address, Port Number, and Encryption Key	52
OmniPro II Ethernet Connections	52
Connecting to Network via PC Access	52
Dynamic DNS	53
SETUP.....	55
Configuration and Advanced Control Programming (ACP).....	55
Set Up Codes.....	55
Authority Level.....	55
1 = Master	55
2 = Manager.....	55
3 = User.....	55
Access Areas.....	55
Duress Code.....	56
Set Up Time	56
Advanced Control Programming (ACP).....	57
1 = Add Programs	57
2 = Show Programs.....	57
3 = Delete All Programs	59
Edit Programs.....	59
Edit Programs When	60
Times Programs	60
Button and Event Programs	61
Control Unit / Switch Press Event Buttons	61
Security Mode Event Buttons	62
Zone Event Buttons.....	63
All On/Off Event Buttons	63
UPB Link Event Buttons.....	63
Alarm Event Buttons.....	64
X-10 Event Buttons.....	64
Miscellaneous Event Buttons.....	64
Message Event Buttons (Pro-Link).....	65
Switch Press Event Buttons (CentraLite).....	65
Edit Program Command.....	66
Program Control Commands	66
Unit Toggle Command.....	67
Program Security Commands	67
Program Button Commands.....	67
Program All On / All Off Commands	67
Program Video Commands*	68
Program Temperature Commands	68
Program Energy Cost	68
Program Message Commands.....	68
Edit Program Condition	69
Program Control Conditions	69
Program Security Mode Conditions.....	69
Program Zone Conditions	69
Program Time Clock Conditions	70
Program Other Conditions	70

Set Up Dial	71
Telephone Access	71
Answer Outside Call.....	71
Remote Commands.....	71
Rings Before Answer.....	71
Dial Type	71
My Phone Number.....	71
Dial Out Number 1	72
Dial Out Numbers 2-8.....	72
Dial Order	72
Set Up Arming.....	73
Entry Delay	73
Exit Delay	73
Audible Exit Delay	73
Entry/Exit Chime	73
Perimeter Chime	73
Enable Quick Arm	74
Enable Auto Bypass.....	74
All On For Alarm.....	74
Beep On Trouble.....	74
Set up Miscellaneous	74
High Security Mode.....	74
Announce Alarms	74
Enable Freeze Alarm	75
Flash For Alarm.....	75
House Codes 1-16 Format	75
House Codes 1-16 All Off	75
Time Clocks.....	76
Latitude, Longitude, and Time Zone	77
Daylight Savings.....	77
Controller IP Address	78
Controller Port Number	78
Encryption Key.....	79
Set Up Names	79
Set Up Voice.....	80
Set Up Address	80
UNDERWRITER'S LABORATORIES REQUIREMENTS	81
FIRE ESCAPE PLANNING.....	81
FEDERAL COMMUNICATION COMMISSION NOTICE:	82
CANADIAN INDUSTRY CANADA NOTICE.....	83
APPENDIX A - DIAL OUT PLANNER.....	84
INSTRUCTIONS TO CALLED PARTY.....	85
APPENDIX B - TEXT DESCRIPTION CHARACTER CODES.....	86
APPENDIX C - VOICE DESCRIPTION CODES.....	87
NOTES ON CUSTOM PHRASES.....	90

INTRODUCTION

Thank you for purchasing your new OmniPro II automation system. You are about to enjoy a new feeling of security, comfort, convenience, and control. OmniPro II coordinates lighting, heating and air, security, scenes, and messages based on your lifestyle and schedule.

Please take a few moments to become familiar with all of the features of your system by reviewing this manual. Please keep this manual on file for future reference.

It is recommended that you also review the installation and operating instructions provided with your smoke and gas detectors (if used in your system). If you do not have a copy of these documents, ask your installer - **See Underwriter's Laboratories Requirements.**

In the event that there are any questions, please call your installer first. If you need assistance directly from the manufacturer, call us at (985) 624-2606, between the hours of 9:00 AM and 5:00 PM Central Time, Monday-Friday. We will be happy to assist you.

When calling, please have the model and serial number of your unit, which can be found on the inside of the controller.

For your convenience, we suggest that you record this information:

MODEL NUMBER: _____

SERIAL NUMBER: _____

Underwriter's Laboratories (UL) Listing

The 20A00-2, -5, and -22 OmniPro II controllers and consoles have been tested and Listed by UL for the following applications:

- UL 985 - Household Fire Warning System Units
- UL 1023 - Household Burglar Alarm System Units (Grade A)

The 20A00-5 OmniPro II controller has also been tested and Listed by UL for the following applications:

- UL 365 - Police Station Connected Burglar Alarm Units and Systems (Grade A)
- UL 609 - Local Burglar Alarm Units and Systems (Grade A)
- UL 1610 - Central Station Burglar Alarm Units (Grade B, C)

In a UL Listed Installation, failure to operate and program the system as described in this manual is a violation of the Listing Mark.

See Underwriter's Laboratories Requirements for more information.

OVERALL DESCRIPTION

Console Operation

The console is designed with everything that is necessary for you to program and operate your OmniPro II control and security system. Because we feel that it is very important for you to feel comfortable with the operation of your OmniPro II, we recommend that you start by becoming familiar with your console.

The OFF (1), DAY (2), NIGHT (3), and AWAY (4) keys are called shortcut keys. This means that you may press these keys to go directly to that function without having to go into one of the "hidden" menus.

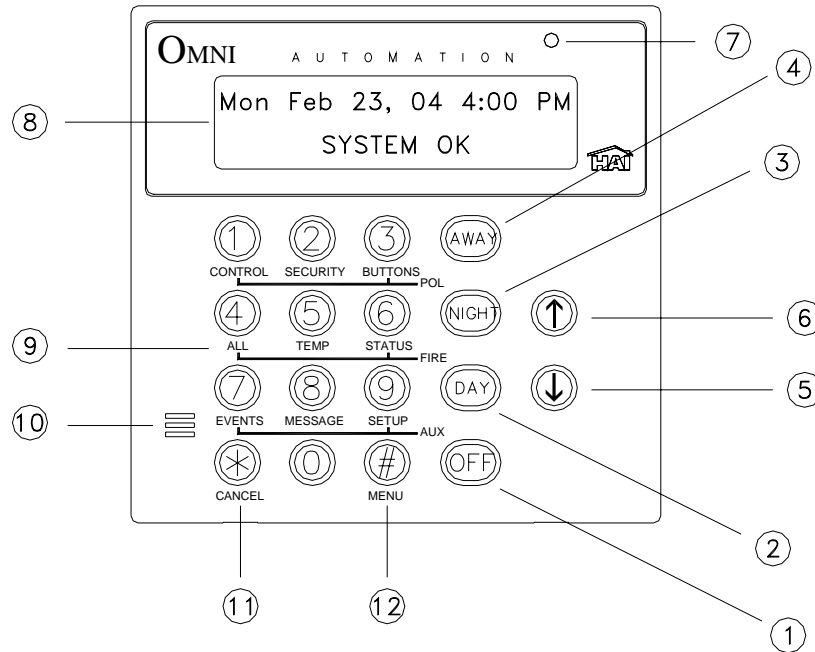

1- ' OFF '

The ' OFF ' key is used to disarm (deactivate) the security system, reset the fire and emergency alarms, and silence all sirens and sounders.

2- ' DAY '

The ' DAY ' key is used to arm the security system in the Day mode. In the Day mode, the perimeter zones (doors and windows) are protected, however, the interior zones are not armed so that you may move about freely inside. In this mode, there is an entry delay on entry-exit zones.

3- ' NIGHT '

The ' NIGHT ' key is used to arm the security system in the Night mode. In the Night mode, the doors, windows, and non-sleeping area motion detectors are armed. In this mode, there is no entry delay so the alarm will be activated immediately if any zone is violated.

4- ' AWAY '

The ' AWAY ' key is used to arm the security system in the Away mode. In the Away mode, all zones (doors, windows, motions, etc.) are armed. There is an entry delay on entry-exit zones, so that you can disarm the system when you return through the door.

5- Down Arrow

The Down Arrow key is used to scroll through menus and lists. The down arrow is used to scroll down the list from first to last (for example, when the first program is being displayed, pressing the down arrow will cause the next program to be displayed).

6- UP ARROW

The Up Arrow key is used to scroll through menus and lists. The Up Arrow is used to scroll back through a list (for example, if you have already used the down arrow to scroll to an item, the Up Arrow will bring you back to a previous item).

7- CONSOLE LED

The Console LED is used to indicate whether the security system is currently armed or disarmed. If armed in any security mode, the LED is set to red. If the system is disarmed, the LED is set to green. The LED flashes when a Message is displayed.

8- CONSOLE DISPLAY

The Console Display is used to show the current security mode and to give useful information that will guide you through normal operations of your OmniPro II control and security system.

9- CONSOLE KEYPAD

The Console Keypad is used to enter user codes for arming, disarming, bypassing, and restoring zones. In some cases, the keys (0-9) are assigned to different functions. From the top-level display, each key functions as a menu choice.

10- CONSOLE BEEPER

The Console Beeper is used to confirm a keystroke, alert user of errors and troubles, and sound upon entry and exit delays.

11- ' * ' KEY

The ' * ' Key is used to cancel and return the display to the previous menu. When you are entering a number, ' * ' will cancel the previously entered digits and will prompt you to reenter the number.

12- ' # ' KEY

The ' # ' Key is used to enter or confirm a selection. It may also be used to display a menu or to offer you additional choices.

Normal Top-Level Display

In its normal state, the console display will show the day, date, and time on the top line, and the system status on the bottom line. If all doors, windows, sensors, etc. are closed, no zones are bypassed, and if there are no troubles, the bottom line will show "SYSTEM OK" as seen below:

```
Thu Feb 23, 06 4:00 PM
SYSTEM OK
```

If one of the doors, windows, motion, or other detector connected to the OmniPro II is open, or has detected motion, the bottom line of the display will say, "ZONE NAME NOT RDY".

For example, the display will show, "FRONT DOOR NOT RDY".

If the zone name has not been entered during set up, the display will give the zone number and zone type. This display will remain for 2 seconds, then the next zone not ready, in trouble, or bypassed will be displayed.

Display Menus

The system has been designed to be easy to operate. Whenever you press a key on the console, the top line of the display will indicate what you are doing. To the right of that is your selection or current setting. The bottom line will show a menu of your next options. To the lower right corner of the display is the direction arrow(s). Where possible, the up (↑), down (↓), and two-headed (↕) arrow characters are shown on the console display to indicate which arrow keys may be pressed at that time.

When using the arrow keys to scroll through lists of areas, buttons, codes, temperature zones, units, or zones, only the named items are displayed. If no text description has been given to an item, it will be skipped over when scrolling through that list. You can still enter any item number to access it directly, and then scroll up and down among the named items. To look at another specific item, simply enter the item number followed by the Down Arrow key.

In some cases, the keypad keys (0-9, *, #) are assigned to different functions or menus. A key assignment is indicated by the character key directly in front of the new function on the bottom line of the display. For example, if the bottom line says, "2=DELETE", you may press the 2 key to delete. From the top-level display, each key functions as a menu choice. Simply press the appropriate key and you will enter that menu.

Main Menu

The main menu is entered from the top-level display by pressing the '#' key. This menu displays all of the functions that you can perform from the console. It is not necessary to display the main menu before selecting a function if the number for the desired menu item is known. The following menu choices are available:

1=CONTROL	2=SECURITY	
3=BUTTON	4=ALL	↓
5=TEMP	6=STATUS	
7=EVENTS	8=MESSAGE	↑
9=SETUP		↑

Menu 1 - Selects Control functions for controlling lights and appliances.

Menu 2 - Selects Security functions (arming, disarming, bypassing, and restoring).

Menu 3 - Allows a Button (macro) to be activated.

Menu 4 - Selects All Lights On / All Units Off commands and Leviton Scene Control commands.

Menu 5 - Allows Temperature control for Thermostats and Energy Saver Modules.

Menu 6 - Allows various status items to be displayed.

Menu 7 - Allows you to view an event log of security "happenings".

Menu 8 - Allows you to play, record, show, log, clear, say, or phone a message.

Menu 9 - Allows you to enter setup mode for different operating configurations.

Error Beeps

If you press a key that is invalid for the function that you are doing, the console will beep 3 times, indicating that it is not a valid option. Look at the bottom line of the display to see what keys you can press next.

Trouble Beeps

The OmniPro II constantly checks the entire system for proper operation. If trouble is found, the trouble is displayed on the bottom line and the console will beep at the rate of two beeps per second to alert you to the trouble. This feature can be turned off if desired - See *Set Up Arming, Beep On Trouble*.

To silence the beeper, press the '* ' key.

For more information, see *Trouble Indications*.

Confirmation Beep

When you have successfully completed a function, such as entering a program or changing a setup item, the console will beep once.

Cancel

If you are ever unsure and wish to return to the top-level display, press the '*' key. You may have to press it more than once, depending on how far into the function (menu) you are. Each time you cancel out of an operation, the console will beep once to indicate that you have canceled.

The '*' key can also be used if you make a mistake while entering a number. For example, if you enter a 2 when you meant to enter a 3, press the '*' key to start over.

Time Out

If you are called away from the console for any reason (to take a phone call, for instance) while you are engaged in an operation, the console will "time out" and cancel it for you after 3 minutes. The display will return to the normal top-level display.

Areas

If there is an area or a separate building that needs to be protected, your installer can divide your OmniPro II system into two independent security systems: Area 1 through Area 8 (up to 8 Areas). Each area has complete access to all of the capabilities of the OmniPro II, yet the OmniPro II can protect each area individually.

You may decide to use the Area feature if you have a guesthouse or workshop that you would like to have protected separately from your home, or maybe you have a business and would like to protect an inventory stockroom separately from the offices in your building.

The console in each area acts as if it were controlling its own OmniPro II system. Each area is assigned, by your installer, a console, a group of zones, control units, macro buttons, messages, and thermostats. These items can only be controlled where they have been assigned.

OmniPro II Maintenance

Your OmniPro II controller and the consoles are designed to require very little maintenance.

For smoke detectors, motion detectors, and other components not manufactured by HAI and follow maintenance procedures outlined by the manufacturer.

Consoles can be cleaned using a mild detergent and a soft cloth.





Every three years, or if the "BATTERY LOW TROUBLE NOW" indication comes on and stays on for an extended period without reason, the rechargeable battery in the controller should be replaced. The recommended battery type is a 12-volt, 7 amp-hour sealed lead-acid battery.

To replace the battery, disconnect the red battery wire from the battery (+) terminal. Cover the connector at the end of the wire with electrical tape to avoid its touching anything in the enclosure. Disconnect the black wire from the battery (-) terminal and cover the connector at the end of the black wire with tape. Remove the old battery. Install the new battery by reversing the removal procedure. Be very careful to connect the Black wire to the (-) terminal on the battery; Red wire to the (+) terminal.

SECURITY SYSTEM OPERATION

Disarming the Security System and Silencing Alarms

Before going any further, you should know how to disarm your security system in the event that the alarm sounds. Turning the system OFF disarms the burglar alarm, resets the fire and emergency alarms, and silences all sirens and sounders.

Press the OFF key.  Now enter your four digit Code.    

That's all there is to it.

Watch the display. The top line will read "DISARM" - The bottom line will read "ENTER CODE", indicating that your option is to enter your code number. For each digit that you press, an "X" will appear indicating that the key has been pressed.

After the four-digit code has been successfully entered, the console will beep once to indicate that you have correctly disarmed the system. The console LED will be set to green, and the display will return to the normal top-level system display.

If an incorrect code is entered, the console will beep three times and display " *** INVALID CODE *** ".

Re-enter your code.

In the event that you make a mistake, press the OFF key again, and then enter your master code again.

Practice disarming your system until you are comfortable with this procedure.

NOTES:

- Panic, Tamper, and Fire zones are always armed, as are the Emergency buttons on the console.
- In the event that the alarm has been activated, the menu keys and the arrow keys are locked out. You must silence the alarm using the OFF, DAY, NIGHT, or AWAY keys.

Arming the Security System

Now that you know how to disarm the system, here's how to arm the security system. The security menu is used to arm and disarm the security system. To enter the security menu, from the top-level display, press the 2 key on the console keypad. The console should display:

```
0=OFF    1=DAY    2=NIGHT
3=AWAY   4=VACATION  ↓
5=DAY INST  6=NIGHT DLY
8=BYPASS  9=RESTORE  ↑
```

0 = OFF

The OFF key disarms the security system, resets the fire and emergency alarms, and silences all sirens and sounders.

1 = DAY

The DAY mode is intended for use when someone will occupy the house or business that is being protected. In the Day mode, the perimeter zones (doors and windows) are armed; however, interior motion detectors and interior traps are not armed so that you may move about freely inside. In the Day mode, there will be an Entry Delay on the Entry-Exit zone, so that someone arriving can turn off the alarm before it sounds.

2 = NIGHT

The NIGHT mode is used when you are asleep and everyone in your household is at home. In the Night mode, your doors, windows, and non-sleeping area (i.e. downstairs) motion detectors are armed. In the Night mode, there is no entry delay. The alarm system sounder will be activated immediately if any door, window, or non-sleeping area (motion detector) is tripped.

3 = AWAY

Use the AWAY mode when you leave your house and no one is home. All doors, windows, and motion detectors are armed. All zones have an Exit Delay so that you will have time to leave and close the door after you arm the system. The system will be fully armed after the Exit Delay. There is an Entry Delay on the Entry-Exit zones in the Away mode, so that you will have time to turn the system off when you return through your door.

Note that the Entry Delay only applies if you come in through an Entry-Exit zone. If someone attempts to climb into a window, or if an interior zone is tripped before the Entry-Exit zone, the alarm will be activated immediately. If you do enter through an Entry-Exit zone first, then the other zones are disabled during the Entry Delay, in case you have to cross through another zone to get to your console (an interior motion detector, for example).

4 = VACATION

This mode arms all doors, windows, and interior motion detectors (same as Away mode). There is an Entry Delay on the Entry-Exit zones. Use this mode when you are leaving for a period of days.

5 = DAY INST (DAY INSTANT)

Functions same as Day mode, however, there is no Entry Delay on any of the security zones. There will be an instant alarm if any of the zones are violated while in this mode.

6 = NIGHT DLY (NIGHT DELAY)

Functions same as Night mode, however, there is an Entry Delay on the Entry-Exit zones. Use this mode if you are going to sleep but a family member is expected home at a later time.

To arm the system into one of the 6 security modes, from the security menu, choose the security mode and press the appropriate key (1 - 6).

Enter your user code number on the console keypad.

The console will beep once and the console LED will be set to red. The top line will display the security mode. The bottom line will display, " *** ARMING SYSTEM *** " to indicate that the system is being armed. The system will be fully armed after the Exit Delay expires. If arming in Away or Vacation mode and Audible Exit Delay is enabled, the console will beep until the Exit Delay has expired. During the last 10 second of the Exit Delay, the console will beep twice as fast so leave and close the door promptly.

NOTE: In Commercial Burglar Alarm Applications for UL Certified Systems, a Ring-back indication and Bell-test should be heard after arming (closing). If not heard, call for service.

Using Shortcut Keys

There are three shortcut keys on the console to arm the system in the Day, Night, and Away security modes, and Off to disarm, without having to go into the security menu.

From the top-level display, press one of the shortcut security keys. Enter your code number on the console keypad.



The console will beep once and the console LED will be set to red. The top line will display the security mode to indicate that you have correctly armed the system. The system will be fully armed after the Exit Delay expires.

The programmed Entry Delay is _____ seconds.

The programmed Exit Delay is _____ seconds.

Quick Arm

For extra convenience, the OmniPro II can be armed by simply pressing the DAY, NIGHT, or AWAY button twice, eliminating the need to enter the code.

To quick arm the system in the Away mode, from the top-level display, press   .

The quick arm feature only works if the alarm system is in the Off mode, and if no alarms are sounding. This feature is disabled when the system is shipped. If desired, it can be enabled or disabled at any time - **See** *Set Up Arming, Enable Quick Arm*.

Bypassing Zones

8 = BYPASS

You can Bypass a zone that you do not want protected while the system is armed. Bypassing is also the only way that a tamper or panic zone can be disarmed. For example, if there is a liquor closet or gun case on a tamper zone, then you must bypass that zone to gain access to it.

Another reason to Bypass a zone is if the zone is having trouble. If a zone is causing a trouble indication, you can bypass that zone to "cut it out" of the system until repairs are made.

When a zone is bypassed, it is no longer checked for alarms. When you bypass a zone using the console (or over the phone) it will **Stay** bypassed until you **Restore** it. The console status display will show that the zone is bypassed only when the security system is disarmed. When the system is armed, it does not display bypassed zones.

To bypass a zone, from the main menu or from the top-level display, press 2 on the console keypad, then 8 for bypass. Enter the zone number followed by the '#' key, or use the arrow keys to select the zone. After the zone is entered, you will be prompted to enter your security code. The bottom line will now read "ZONE NAME BYPASSED" to remind you that the zone is bypassed.

If a fire zone is bypassed, the console will continue to beep until that zone is restored - **See** *Restoring Zones*.

Auto-Bypass

In order to prevent the alarm from sounding unexpectedly if a window or door is open when the system is armed, the OmniPro II will automatically bypass the zone if it is opened when the system is armed.

Note that there is an exit delay before the system is armed in any mode. The bypass will only take place if the zone is **not ready** (i.e. open) when the exit delay is over and the system is actually armed.

When a zone is Auto-Bypassed, it will be automatically restored once it is **secure** (i.e. closed), or the next time you arm or disarm the system. The auto-bypass is recorded in the event log as "ZONE NAME BYPASSED". To prevent any zone from being bypassed unintentionally, you should always look for "SYSTEM OK" on the display before arming and leaving the premises.

The Auto-Bypass feature can be disabled if you do not want the system to automatically bypass open zones. If the auto-bypass feature is disabled, the alarm will sound if a zone **not ready** (i.e. open) when the system is armed.

NOTE: The Auto-Bypass feature is disabled on UL Listed Installations.

Restoring Zones

9 = RESTORE

Restoring a zone puts it back on active duty in the system. When restored, the Bypassed indication will no longer be displayed on the status line and the zone will be checked for alarms.

To restore a zone, from the top-level display, press 2 on the console keypad, then 9 for restore.

Enter the zone number followed by the '#' key, or use the arrow keys to select the zone. Press '0' as the first key to restore all zones. The 0 = ALL choice is removed once a digit key or the down arrow is pressed. After the zone or all zones is entered, you will be prompted to enter your code. The console will beep and the display will return to the top-level display.

#=GOTO

To Bypass or Restore a zone in another area, you must first "go to" that area by selecting #=GOTO.

AREA :
ENTER AREA :

At this point you may enter the area number followed by the ' #' key, or use the down arrow key to scroll to the next area - *See Area Arming* for additional information.

What To Do When You Come Home

Entry through a door:

If you enter your home while the system is armed in the Day or Away modes, using your normal entry door:

- Console beeper comes on - display indicates: " *** DISARM SYSTEM *** - PRESS OFF THEN CODE"
- Any lights or control modules programmed to come on for the door that you used will do so.
- The system will wait the Entry Delay time.

You should go to your console (or telephone) immediately and turn the security system off. If you wish, you may go directly to a different security mode, rather than turning the system Off.

If you return home and hear the alarm sounding, **DO NOT ENTER**. Use a neighbor's phone to call for help.

What Happens When the Alarm is Activated

Burglar Alarm Activated

If someone enters through any zone other than an Entry-Exit zone, if the security system is in the Night mode, or if the security system is not turned off during the Entry Delay:

- The sounder is activated, which makes a loud, continuous sound.
- The display shows the type of alarm and the zones that have been tripped: "BURGLAR ALARM! - ZONE NAME TRIPPED".

If more than one zone is tripped, then the bottom line will show each zone tripped for two seconds.

- The When Alarm macro is activated. Any units programmed to come on will do so.
- The Flash For Alarm Unit Number begins to flash on and off.
- The system waits the Outside Siren Delay (0 - 60 seconds), then activates the sounder.
- The system waits the Dial Out Delay (0 - 60 seconds), then if programmed, the in-house phones are seized (disconnected) and the OmniPro II begins to dial out.

If you are having your system monitored by a central station, the central station will be sent a code representing the type of alarm (burglary) and zone involved. In most cases, the central station will call back, requesting your password or passcode.

If you are not using central station monitoring but are using the voice dial out capability, the system looks at the Dial Order to determine which number to call first, and calls that number.

If you are using both central station monitoring and voice dial out, then the voice dial out is delayed by five minutes to give the central station time to call you back.

For more information on the digital and voice dialer - **See** *Digital Dialer* and *Voice Dialer*.

- The system continues to sound all alarms and flash the flashing light for 1-30 minutes after the alarm is activated.
- After a 1-30 minute period, the sounder is turned off, and the alarm system resets itself. The console beeper stays on. If a zone is tripped after a reset, the sounder will again be activated, and the dialer will again dial out.

At any time, the alarm system can be turned off at the console.

Fire Alarm Activated

When the fire alarm is activated by the smoke/fire detector(s), the alarm responds exactly as described under Burglar Alarm Activated, except:

- The console display reads, "FIRE ALARM! ZONE NAME TRIPPED".
- The sounder will activate in a 3 pulse temporal pattern to distinguish the fire alarm from the burglar alarm.

The fire alarm takes priority over the burglar alarm, however, if a gas alarm is already active, it will not override the gas alarm.

NOTE: If multiple alarm types occur, such as both Fire and Police, the display will alternate between the alarm types.

Gas Alarm Activated

When the gas alarm is activated, the alarm responds exactly as described under Burglar Alarm Activated, except:

- The console display reads, "GAS ALARM! ZONE NAME TRIPPED".
- The sounder will pulse on - off - on, then an extended off period to distinguish it from the burglar or fire alarm.

The gas alarm takes priority over the burglar alarm, however, if a fire alarm is already active, it will not override the fire alarm.

Emergency Keys

Emergency alarm conditions can be activated through the console. These conditions (Fire, Police, and Auxiliary) are initiated with the simultaneous depression of two keys for approximately 1-second.

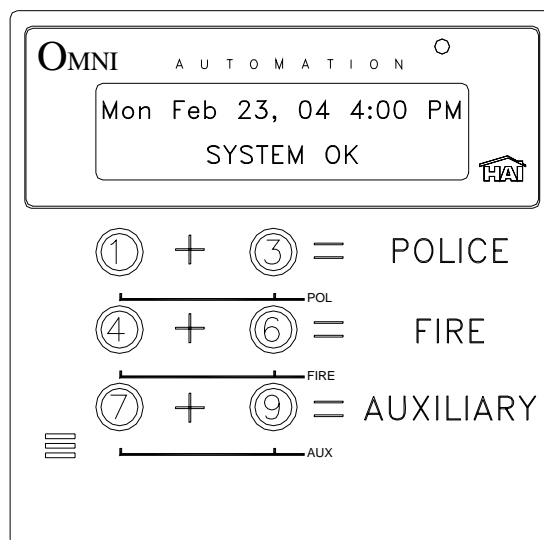

NOTE: The Emergency keys are always armed. The Fire and Auxiliary emergency alarms are silenced by pressing the ' * ' key. To cancel a Police emergency alarm you must press the Off key and enter your code.

Police Emergency

When the 1 key and the 3 keys are pressed simultaneously, the Police Emergency alarm is activated. This alarm operates exactly the same as described for Burglar Alarm Activated except:

- The console display indicates: "BURGLARY! - POLICE EMERG TRIPPED".
- The interior sounder and the outdoor siren are activated immediately. There is no outside siren delay.

Fire Emergency

When the 4 key and the 6 key is pressed simultaneously, the Fire Emergency alarm is activated. This alarm operates exactly the same as described for Police Emergency Button except:

- The sounders activates in a 3 pulse temporal pattern distinguish the fire alarm from the burglar alarm.
- The console display will read: "FIRE ALM - FIRE EMERG TRIPPED".

The Fire Emergency alarm can be turned off at any time by pressing the '*' key.

Auxiliary Emergency

When the 7 key and the 9 key is pressed simultaneously, the Auxiliary Emergency alarm is activated.

- The console beeper comes on - display indicates: "AUX ALARM! AUX EMG BTN TRIPPED".
- The console beeper continues to sound until the alarm is reset.

Duress Code Entered or Duress Alarm Activated

(See *Duress Code* for a description of when to use)

In the event that you enter your duress code or a Duress zone is tripped, the system performs a silent dial out as follows:

- No alarms, lights or console beepers are activated. The system does not display the duress alarm.
- The system waits the dial out delay, then begins to dial out.

If you are having your system monitored, the central station will be sent a code representing a silent alarm (duress).

Alarm Reset

The alarm system will reset itself after the outside siren has been on for 1-30 minutes. When the alarm system resets, any zone that is **ready** is reactivated, so the alarm system will be activated again if the zone is tripped. If a zone remains **not ready** (i.e. a door has been left open) it will be automatically bypassed when the alarm resets.

Alarm Cancel

At any time, you can silence your alarm system by pressing the Off key and entering your code. If the system has reported, or is in the process of reporting an alarm to a central station, it will send the alarm code followed by a code indicating that the user has canceled the alarm. If an alarm is canceled before the dial out delay has expired, the system will not report any alarm.

If an alarm is canceled during a voice dial out, the system hangs up immediately.

Trouble Indications

The OmniPro II constantly monitors the alarm zones and several internal matters and will alert you if it detects trouble. The particular trouble is indicated on the bottom line of the display and a trouble signal is given by beeping the console beeper continuously, 2 beeps per second.

When any trouble condition occurs, the console will beep twice per second and continue to beep until the ' * ' key (cancel) is pressed to acknowledge the trouble. The console will say "TRBL NOW" (trouble now) if the trouble condition actually exists while you are looking at the console. It will say "HAD TRBL" (had trouble) if the trouble occurred and then corrected itself.

The following are trouble indications and their meanings:

- **ZONE NAME TRBL NOW or HAD TRBL:** If the reading for a zone becomes abnormal, trouble will be indicated on that zone -*See Status \ Test*. Excessive resistance in the contact and wiring usually causes trouble on security zones. If the cause is not obvious, call your installer for service.
- **AC POWER OFF TRBL NOW or HAD TRBL:** Indicated if the normal house current powering the OmniPro II controller is interrupted for more than 3 minutes. If this happens without good cause, check the wall mounted transformer to ensure that it hasn't come out of the wall socket and check to see that the socket has power.
- **BATTERY LOW TRBL NOW or HAD TRBL:** Every hour, the OmniPro II takes a dynamic test of the battery. If the battery voltage is too low, then the console will indicate "BATTERY LOW". If this happens, make sure that the battery is connected. The "BATTERY LOW" indication will remain until the next battery test is executed, 1 hour later, or when a Status | Test command is given.
- **COMMUNICATOR TRBL NOW or HAD TRBL:** Indicated if the digital communicator (not the voice dialer) was unable to make contact with the Central Station after trying both numbers multiple times. If this happens, there could be a problem with the system, central station, or the phone line. Call your installer for service.
- **FUSE TRBL NOW or HAD TRBL:** Indicated when the solid state fuse that protects the "Auxiliary" power supply opens. The fuse will automatically reset when the fault condition is cleared.
- **PHONE LINE DEAD TRBL NOW or HAD TRBL:** Indicated if the phone line is dead for more than 1 minute.

To silence the trouble beeps on the console, press the ' * ' key. If more than one type of trouble has occurred, the display will show each one for two seconds. Pressing the ' * ' key will acknowledge all trouble indications.

If the trouble condition occurs again, the console beeper will beep again - *See Set Up Arming, Beep On Trouble* if you wish to disable the beeper.

- **NO CONTROLLER DATA:** Indicated when console's alarm functions are no longer operational. This may indicate a wiring problem to the console or a more serious problem. Call your installer for service.

Codes

There are 99 user codes that you may assign to users of the system. All OmniPro II codes are 4 digits in length. A code can be any number from 0001 to 9999. Each user should be assigned a security code with an authority level, areas that can be accessed (if area arming is used), and times and days in which the code will be valid. Memorize your codes! Don't give them to anyone who doesn't need to know them.

The levels of authority that you can assign to a user code are Master, Manager, and User.

Master Code

The Master code allows complete access to the entire system. Only the owner(s) or the one(s) who will govern the system should have and use the master code. A Master code is allowed access to all areas, all the time.

User code 1 is always set to a Master code - *See Set Up Codes*.

Manager Code

The Manager codes can arm/disarm the security system in assigned areas, during assigned times. The Manager code can access functions that are code protected in High Security mode. Managers may also access the system from an outside telephone line.

User Code

User codes can only be used to arm and disarm the security system in assigned areas when the time assigned to that code is valid.

Duress Code

If you are forced to disarm the system against your will by an intruder, disarm it as you normally would, but use the Duress Code instead of your normal code. The system will disarm normally. No sirens will sound, no lights will flash, but the OmniPro II will perform a silent dial out and say that this is a silent alarm.

To stop a silent dial out, turn your security system off the usual way, pressing Off key, then your code.

Panic Switches

If you have had panic switches installed, they are always armed. Pressing a panic switch will cause the alarm to activate. This alarm can only be silenced by pressing the Off key and a valid code on the console.

Area Arming

If your installer has enabled the Area feature, the security system may be armed in Area 1, and disarmed in Area 2. In fact, each area may be armed in different security modes at the same time. Each area will have its own console that will control that area independently from the other.

When disarming the security system or arming the security system in any mode, the system will automatically control all security functions in the area of that console if your code is valid for that area.

If you have a Master code, your code is valid in any area. If you are in Area 2, and wanted to arm the system in the Away mode, simply press the Away key and enter your code. The system will automatically arm Area 2. The security mode in Area 1 will not change.

If you have a code that is only valid in Area 1, you will not be able to disarm or arm Area 2.

If you are in Area 1 and wish to disarm the security system in Area 2, OmniPro II will allow you to disarm Area 2 from the console in Area 1 if you have a Master code or a code that is valid for both areas.

From the top-level display or from the main menu, press the 2 (SEC) key on the console keypad.

Press the 0 (OFF) key, the display will show:

```
DISARM
ENTER CODE :      #=AREA
```

Press the '#' (AREA) key, the display will show:

```
AREA :
ENTER AREA      0=ALL ↓
```

The Area number can be entered followed by the '#' key, or the arrow keys may be used to scroll through a list of areas. If the '0' key is pressed, then all areas will be selected.

Press the 2 key then the '#' key. You will then be prompted to enter your code. The display will show:

```
DISARM AREA 2
ENTER CODE :
```

If the '0' (ALL) key had been selected, the display will show:

```
DISARM ALL AREAS
ENTER CODE:      #=AREA
```

As the four-digit code is entered, "X" characters are echoed after the "ENTER CODE:" prompt.

If the Master code or a valid code is entered, the console will beep one time and Area 2 will be disarmed.

Even if Auto Bypass is enabled, the system will not arm another area if any zones in that area are not ready. If any zone in Area 2 is not ready (open), after you enter the code, the console will beep three times and display "AREA 2" on the top line, and "ZONE NOT READY" on the bottom line.

```
AREA 2
ZONE NOT READY  #=RETRY
```

In order to arm Area 2 from a console in Area 1, you must first secure or Bypass any zones in AREA 2 that are "Not Ready". Press the '#' key to retry the arming process.

To Bypass or Restore a zone in Area 2 from a console in Area 1, or viceversa, it is first necessary to "go to" that area.

GOTO Area

From the security menu, press the # (GOTO) key on the console keypad.

```
AREA :
ENTER AREA      ↓
```

The Area number can be entered followed by the '#' key, or use the arrow keys to scroll through a list of areas. Once the area is selected, you are prompted to enter your code:

```
GOTO AREA 2
ENTER CODE
```

The console (AREA 1) will now be temporarily assigned to the selected area (AREA 2) if a valid code for that area (AREA 2) is entered. All security and control commands will now operate on the selected area (AREA 2), just as if you were physically at a console assigned to that area (AREA 2). All status displays will show the status of the selected area.

The top line of the display will show the name and security mode for that area.

Use the "go to" function again to return to the area normally assigned to that console (AREA 1). The console will automatically return to its normal area after three minutes of inactivity at the console.

Testing Your System

HAI recommends testing your system on a weekly basis to ensure that you are fully protected.

1. Notify your Central Station that you intend to test the system. To test the siren, press the 1 and 3 keys simultaneously. Press OFF and enter your Code to cancel the alarm and silence the siren.
2. To test the security zones, you will need a partner to walk around your home and open and close all doors, windows, etc. that are connected to the system while you watch the console. Have a partner open each door and window, then close it. The display should show the zone name as being "NOT RDY" and then return to "SYSTEM OK" when closed.
3. Have your partner walk in front of all motion detectors (if installed) and verify that the console responds in a similar fashion.
4. Test your smoke detectors as recommended by the manufacturer. Be ready to silence the alarm system as soon as it sounds.
5. From the top-level display or from the main menu, press the 6 key then the 4 key.
 - The Battery reading should be over 200 - **See Status \ Test.**
6. Pick up an inside phone and press the # key. When the menu is spoken, press 8, Then 3. The OmniPro II should say "ADDRESS IS: "and play your name and address. If it does, the telephone dialer, telephone access and telephone control systems are all working correctly.
7. If you wish to test your system's link to your Central Station monitoring service, call them first and inform them that you will be testing your alarm system. Set off the alarm, allowing sufficient time for any dial out delays that you may have, then turn the alarm system Off. The Central Station should receive the alarm code.
8. Remember to inform your Central Station when the test is complete.

CONTROL

Control Commands

The control features of the OmniPro II make it easy and convenient to control almost any light or appliance from the console or over the telephone. You may also have your heating and air conditioning (HVAC) under control of the system, which will allow you to save energy dollars by setting the temperature appropriately when you are home, asleep, or away.

Furthermore, the OmniPro II can be used to program lights to make the home or business look occupied as a deterrent to thieves.

The methods that the OmniPro II uses to control different devices are:

- UPB switches, modules, and keypads for lights and appliances
- Centralite loads and relays on a LiteJet and Elegance lighting system
- RadioRA switches and dimmers on a Lutron RadioRA lighting system
- ALC switch modules for lights and appliances
- X-10 compatible modules (X-10, X-10 Pro, Leviton, PCS, ACT, Lightolier, etc.) for lights and small appliances.
- HAI Communicating Thermostats for controlling Heating, Ventilation, and Air Conditioning Systems.
- Programmable Energy Saver Modules (PESM) for central heating and air conditioning systems.
- Direct Output Control for relays to activate sprinklers, lighting, electric heating, etc.

An OmniPro II will control:

- 250 UPB switches, modules, and keypads (up to 31 rooms of HLC Lighting)
- 192 Centralite loads and relays
- 64 RadioRA switches and dimmers
- 248 ALC switch modules
- 256 X-10 compatible modules (all sixteen house codes)
- 64 HAI Communicating Thermostats
- 8 PESMs or Voltage Outputs (expandable to 136)

OmniPro II also has 119 internal "flags" that are used for programming conditionals and executing programs.

About UPB

UPB is a powerline communications standard for lighting and home control. UPB is a robust, two-way digital powerline carrier communications protocol which transmits signals over the existing wires in a home. UPB can coexist peacefully with X-10 systems, intercoms, baby monitors, speakers, etc. that communicate over the powerline.

Using a Powerline Interface Module (PIM), OmniPro II sends UPB commands over the existing electrical wiring to special switches, modules, and keypad controllers (UPB devices) that are designed with UPB technology. UPB switches are two-way devices, so OmniPro II knows the actual status of the switch when it is controlled locally. In addition, UPB switches, modules, and keypads can be used to trigger macros in the OmniPro II controller.

When set to UPB, the OmniPro II controller can:

- Send commands (on, off, bright, dim and level) to individual switches and modules
- Receive commands and status from individual switches and modules
- Send commands to keypad controllers to change scenes and control LED backlight behind the keys
- Receive commands when buttons are pressed on keypad controllers to activate controller macros
- Send Link commands to switches, modules, and keypad controllers to activate scenes
- Receive Link commands when a button is pressed on a switch or on a keypad controller to activate controller macros
- Send “Status Request” messages to switches to update their status in the controller
- Receive the UPB Acknowledgement pulse that indicates that a switch has properly executed a command

HAI Lighting Control (HLC) Format

HAI Lighting Control (HLC) combines HAI UPB™ Wall Switches, Dimmers, and Modules, HAI UPB™ Room Controllers, and HAI UPB™ House Controllers to create lighting scenes that set the proper mood and ambiance for various activities.

HLC format is a defined structure for configuring, programming, and operating all the HLC lighting devices in your home. Each “House Code” that is configured to use the HLC format consists of 2 rooms with up to 8 HLC devices in each room. OmniPro II supports up to 31 rooms of HLC lighting. OmniPro II can control up to 248 HLC devices.

HAI manufactured UPB™ devices (collectively referred to as HLC devices) can be configured using an Omni console or OmniTouch touchscreen connected to the OmniPro II controller. Other UPB™ devices may be used in the HLC structure, but cannot be configured using the OmniPro II controller; they must be configured using a PC running the UPB™ UPStart configuration software – see *Configuring HLC Devices*.

About Rooms

Each “room” of HLC lighting consists of 8 consecutive unit numbers, starting at Unit 1 (i.e. Room 1 = Units 1-8, Room 2 = Units 9-16, Room 3 = Units 17-24, etc.). Each room can consist of a maximum of 8 HLC devices, configured as follows:

- Up to 7 HAI UPB™ Wall Switches, Dimmers, and/or Modules (for controlling up to 7 lighting loads in a room or area)
- 1 or more Room Controllers (set a scene in a room, turn the room on and off, and dim and brighten the room)
- 1 House Controller (for controlling up to 8 rooms of HLC lighting)
- 1 or more House Controllers (used as a general purpose 8 button keypad controllers)

The first unit number in each room (i.e. 1, 9, 17, 25, etc.) is reserved for controlling the room. The name for this unit should reflect the room name (e.g. Kitchen, Great Room, Theater, etc.) HLC Wall Switches, Dimmers, or Modules cannot be programmed to these unit numbers. If one or more Room Controllers are used, the first Room Controller should be set to the first unit number in the group (i.e. Unit 1); additional Room Controllers can be used by setting each to any other unused unit number in the group (i.e. Units 2-8).

About Room Controllers

The HAI UPB™ 6-Button Room Controller allows for lighting control of a room where HAI UPB™ Wall Switches, Dimmers, and Modules have been installed. From a Room Controller the room can be turned off (all loads in the group are turned off), turned on (all loads in the group are turned on), brightened (all loads are brightened from their current level), dimmed (all loads are dimmed from their current level), or set to one of 4 lighting scenes (A-D).

Room Controller LED Indicators

When the room is turned on, the LED indicator behind the “On” button is illuminated and all others are turned off. When the room is turned off, the LED indicator behind the “Off” button is illuminated and all others are turned off. When the room is brightened, the LED indicator behind the “On” is illuminated and all others are turned off. When the room is dimmed, the LED indicator that is currently illuminated stays on. When the room is set to a lighting scene (A-D), the LED indicator behind the respective scene letter is illuminated and all others are turned off.

When “Status Tracking” is enabled (this is the default setting), OmniPro II keeps track of the exact status of each unit even when a lighting scene is initiated by the Room Controller. Room Controllers also keep track of when individual switches in a room are turned on and off. When all of the lighting loads in a room are turned off, the “Off” indicator is illuminated. If any of the lighting loads in a room are turned on at an HAI UPB™ Wall Switch or Dimmer, the “On” indicator will illuminate and the “Off” indicator is turned off. Likewise, if the “On” indicator or one of the scene indicators is illuminated, and then all of the lighting loads are turned off at HAI UPB™ Wall Switches, the “Off” indicator will illuminate and any others are turned off.

About House Controllers

The HAI UPB™ 8-Button House Controller allows for controlling all 8 rooms of lighting where HAI UPB™ Wall Switches, Dimmers, and Modules have been installed. It can also be configured as a general purpose 8 button keypad controller used to trigger 8 different macro programs in the OmniPro II controller or to toggle between two different actions (i.e. turn lighting load on...turn lighting load off) each time a pushbutton is pressed.

When used to control rooms of lighting in the HLC structure, each button on the House Controller is used to toggle all of the lights in the respective room on and off. When the room is turned on, the LED indicator behind the respective button is illuminated and all of the lights in the room are turned on. When the room is turned off, the LED indicator behind the respective button is turned off and all of the lights in the room are turned off. If a lighting load in the respective room is turned on, the LED indicator behind the button is illuminated. When all lighting loads in the respective room are turned off, the LED indicator behind the button is turned off.

When used to control rooms of lighting in the HLC structure, each House Controller controls 8 consecutive rooms (i.e. Room 1-8, Room 9-16, Room 17-24, and Room 25-31). To configure a House Controller to control a group of 8 rooms, it must be set to the last unit number in one of the respective rooms. For example, a House Controller set to Unit 8, 16, 24, 32, 40, 48, 56, or 64 is configured to control rooms 1-8. This allows you to have up to 8 House Controllers throughout the house that control rooms 1-8.

Within the HLC structure, House Controllers can also be configured as a general purpose 8 button keypad controller that is used to trigger 8 different macro programs in the OmniPro II. When configuring a House Controller as a general purpose 8 button keypad controller, it must be set to a unit number between the first and last unit number in a room (i.e. 2-7, 10-15, 18-23, 26-31, 34-39, etc.). When configured as a general purpose 8 button keypad controller, programs must be created in the OmniPro II controller for the LED indicator behind each button to function.

About CentraLite

CentraLite is a centralized lighting control system that uses hardwired lighting control technology to control lighting loads, fans, and mechanical low voltage relays.

CentraLite lighting scenes are used to control groups of lights which are preset to turn on to various levels of dimming.

When set to CentraLite, the OmniPro II controller can:

- Send commands (on, off, and level) to individual loads and relays
- Receive status (on and off) from individual loads and relays
- Execute scene commands (on and off) to control of up to 255 CentraLite lighting scenes
- Receive commands when buttons are pressed on a CentraLite keypad (up to 127)

About Lutron RadioRA

Lutron RadioRA uses wireless communication technology to control lighting. Each Switch or Dimmer controls one Zone, or area, of lighting in a RadioRA system. Accessory Switches and Dimmers are used to control the lights locally from up to 9 additional locations. Master controls provide control and monitoring for all the lights in a RadioRA system.

Phantom Buttons are “virtual” buttons in the RS232 Interface. Though there are no physical buttons that represent these Phantom Buttons, they work very similarly to buttons on RadioRA Master Controls. Phantom Buttons are intended to give the RS232 Interface control over multiple RadioRA Switches and Dimmers with one command. To control more than one device at one time, Phantom Buttons are recommended.

A Zone is any individual RadioRA Switch or Dimmer. A RadioRA System has a maximum of 32 Lighting Zones. Zone Numbers can be used to identify any individual Zone (one Switch or one Dimmer), in a RadioRA system via the RS232 Interface. The Chronos System Bridge and Timeclock bridges two RadioRA systems for a total of 64 Lighting Zone Controls and 24 Master Controls.

When set to RadioRA, the OmniPro II controller can:

- Send commands (on, off, and level) to individual Switches and Dimmers
- Receive status (on and off) from individual Switches and Dimmers
- Receive commands when buttons are pressed on Master Controls
- Execute Phantom Button commands

About ALC

ALC is intended for installation in homes, which have been pre-wired for installation of ALC system products. OmniPro II controls lights and appliances by sending commands over the ALC signal wiring to ALC Switch Modules. ALC Switches communicate with the OmniPro II over low voltage signal wire. They are two-way devices, so the controller always knows the actual status of the switch. In addition, ALC switches can be used to set scenes by triggering macros in OmniPro II.

When ALC Lighting Control Modules are being used, it is also possible to "ramp" the lighting level of an ALC Dimmer Switch to a new level at a controllable ramp rate.

ALC Module Types

The ALC modules types are: Dimmer Switch, Relay Switch, Slave Switch, Program Switch, and 4-Button Scene Switch Modules.

About X-10

The OmniPro II controls lights and appliances by sending commands over your existing electrical wiring to special switches, outlets, receptacles, and modules, collectively referred to as X-10. Each module (or group of modules) is assigned a House Code and a Unit Number so that the OmniPro II can control the modules individually. When a module hears a command from the OmniPro II for its house code and unit number, it executes the command.

There are 3 different X-10 formats: Standard X-10 (Preset Dim), Extended X-10 (Extended Level), and Compose.

Any module that is "X-10 Compatible" will work with the OmniPro II. The modules come in various types.

House Codes

OmniPro II can control up to 256 lighting and appliance devices. Each device (switches, modules, and keypad) has its own Unit Number (1-256). OmniPro II groups devices by "House Code", which consists of 16 consecutive unit numbers, starting at Unit 1. Each "House Code" can be configured to a different lighting protocol format such as: Standard X-10, Extended X-10, Lightolier Compose, UPB (open UPB format where you can use the programming capability in the OmniPro II controller to communicate with the UPB network), Lutron RadioRA, Centralite, or HAI Lighting Control (HLC).

Different lighting devices can not share the same House Code. However, different lighting devices can coexist on an OmniPro II system as long as they are on separate House Codes. For example:

- House Code 1 (Units 1-16) = HLC
- House Code 2 (Units 17-32) = UPB
- House Code 3 (Units 33-48) = X-10 Extended
- House Code 4 (Units 49-64) = Centralite
- Etc.

Unit Numbers

OmniPro II systems have 511 total Unit Numbers. They consist of HLC, UPB, CentraLite, RadioRA, ALC, Compose, and X-10 module unit numbers, hardwire voltage output unit numbers, and internal flag unit numbers as follows:

OmniPro II Unit Numbers	Module / Output Unit Numbers
1 - 16	HLC Room 1 and 2, UPB Unit ID 1-16, CentraLite loads 1-16, RadioRA Lighting Zones or Master Controls 1-16, and X-10 modules 1 – 16 (House Code X)
17 - 32	HLC Room 3 and 4, UPB Unit ID 17-32, CentraLite loads 17-32, RadioRA Lighting Zones and Master Controls 17-32, or X-10 modules 1 – 16 (House Code X+1)
(1 - 31)	ALC addresses 1-31, Module 1 - Branch 1 *
33 - 48	HLC Room 5 and 6, UPB Unit ID 33-48, CentraLite loads 33-48, RadioRA Lighting Zones and Master Controls 33-48, or X-10 modules 1 – 16 (House Code X+2)
49 - 64	HLC Room 7 and 8, UPB Unit ID 49-64, CentraLite loads 49-64, RadioRA Lighting Zones and Master Controls 49-64, or X-10 modules 1 – 16 (House Code X+3)
(33 - 63)	ALC addresses 1-31, Module 1 - Branch 2 *
65 - 80	HLC Room 9 and 10, UPB Unit ID 65-80, CentraLite loads 65-80, or X-10 modules 1 – 16 (House Code X+4)
81 - 96	HLC Room 11 and 12, UPB Unit ID 81-96, CentraLite loads 81-96, or X-10 modules 1 – 16 (House Code X+5)
(65 - 95)	ALC addresses 1-31, Module 1 - Branch 3 *
97 - 112	HLC Room 13 and 14, UPB Unit ID 97-112, CentraLite loads 97-112, or X-10 modules 1 – 16 (House Code X+6)
113 - 128	HLC Room 15 and 16, UPB Unit ID 113-128, CentraLite loads 113-128, or X-10 modules 1 – 16 (House Code X+7)
(97 - 127)	ALC addresses 1-31, Module 1 - Branch 4 *
129 - 144	HLC Room 17 and 18, UPB Unit ID 129-144, CentraLite loads 129-144, or X-10 modules 1 – 16 (House Code X+8)
145 - 160	HLC Room 19 and 20, UPB Unit ID 145-160, CentraLite loads 145-160, or X-10 modules 1 – 16 (House Code X+9)
(129 - 159)	ALC addresses 1-31, Module 2 - Branch 1 *
161 - 176	HLC Room 21 and 22, UPB Unit ID 161-176, CentraLite loads 161-176, or X-10 modules 1 – 16 (House Code X+10)
177 - 192	HLC Room 23 and 24, UPB Unit ID 177-192, CentraLite loads 177-192, or X-10 modules 1 – 16 (House Code X+11)
(161 - 191)	ALC addresses 1-31, Module 2 - Branch 2 *
193 - 208	HLC Room 25 and 26, UPB Unit ID 193-208, or X-10 modules 1 – 16 (House Code X+12)
209 - 224	HLC Room 27 and 28, UPB Unit ID 209-224, or X-10 modules 1 – 16 (House Code X+13)
(191 - 223)	ALC addresses 1-31, Module 2 - Branch 3 *
225 - 240	HLC Room 29 and 30, UPB Unit ID 225-240, or X-10 modules 1 – 16 (House Code X+14)
241 - 256	HLC Room 31, UPB Unit ID 241-250, or X-10 modules 1 – 16 (House Code X+15)
(225 - 255)	ALC addresses 1-31, Module 2 - Branch 3 *
257 – 272	Outputs 1-16, 1st Expansion Enclosure *
273 – 288	Outputs 1-16, 2nd Expansion Enclosure *
289 – 304	Outputs 1-16, 3rd Expansion Enclosure *
305 – 320	Outputs 1-16, 4th Expansion Enclosure *
321 - 336	Outputs 1-16, 5th Expansion Enclosure *
337 – 352	Outputs 1-16, 6th Expansion Enclosure *
353 - 368	Outputs 1-16, 7th Expansion Enclosure *
369 - 384	Outputs 1-16, 8th Expansion Enclosure *
385 - 392	Voltage Outputs (1-8), Fully Configurable
393 – 511	Internal Flags
	“X” Represents the House Code setting on the OmniPro II Controller
	“*” Internal Flags

Scrolling Through Names

The OmniPro II stores names for Units, Zones, Buttons, Codes, Temperatures, and Messages so that you don't have to remember that "UNIT 5" is the "DEN LIGHT" and "ZONE 1" is the "FRONT DOOR". In general, any time you enter a unit, zone, button, code, temperature, or message number, you can press the down arrow key to display its name, then use the up and down arrow keys to scroll through the list of other names. This is true when entering commands and programming on the console. Only named items are displayed on an OmniTouch touchscreen.

Controlling Units

The control menu is used when controlling lights and appliances. To enter the control menu, from the top-level display or from the main menu, press the 1 (CTRL) key on the console keypad. OmniPro II will automatically display the first named item in that list. The down arrow key can then be used to scroll through the list, and the '#' key is used to select the item. If the specific item number is known, enter the item number followed by the '#' key, or scroll up and down among the named items.

After the unit has been selected, press the '#' key. The console will display:

Controlling a Room of HLC Lighting

```
Living Room
0=OFF 1=ON 2-5=A-D    ↓

Living Room
6=SET                #=STA↑
```

- Press 0 (OFF) to turn the selected room off (all lighting loads in the room are turned off).
- Press 1 (ON) to turn the selected room on (all lighting loads in the room are turned on).
- Press 2 (A) to set all of the lighting loads in the selected room to their preset levels for Scene A.
- Press 3 (B) to set all of the lighting loads in the selected room to their preset levels for Scene B.
- Press 4 (C) to set all of the lighting loads in the selected room to their preset levels for Scene C.
- Press 5 (D) to set all of the lighting loads in the selected room to their preset levels for Scene D.
- Press 6 (SET) to set up a lighting scene for the all of the lighting loads in the selected room (On, A-D).
- Press # (STA) to view the current status of the room.

Configuring Lighting Scenes in an HLC Room

Lighting scenes are created by configuring light levels for HLC lighting devices in a room. Each HLC device in a room can store up to four different preset lighting scenes (Scenes A-D) and one "On" Scene (preset lighting levels for each device when the room is turned on). To set a lighting scene using the Omni console, adjust all of the HLC devices in the room to the desired lighting levels. The desired lighting levels (0% - 100%) may be set manually at the switch, or by issuing commands from the OmniPro II controller. After the desired lighting levels are set, use the 6 (SET) command to save the new "light levels" for each device in the selected room.

```
Living Room SET
1=ON 2-5=A-D
```

When the scene command is transmitted (either using a Room Controller or by the OmniPro II controller), each HLC device in the specified room will brighten or fade to its preset level for the selected scene.

Each lighting scene can also be set or easily changed using the pushbuttons on the HAI UPB™ 6-Button Room Controller, as follows:

Step	Operation
1	Press the desired pushbutton on the HAI UPB™ 6-Button Room Controller to activate the current scene (preset lighting level) in each of the HLC devices.
2	Use the local Decora-style rocker switch on each UPB™ Wall Switch Dimmer(s) to set the desired lighting level(s) or issue commands from the OmniPro II controller.
3	Press the pushbutton on the HAI UPB™ 6-Button Room Controller five (5) times quickly.
4	Each UPB™ Wall Switch Dimmer will flash its lighting load one time to indicate that the new level has been configured.

Controlling Individual Lighting Loads in an HLC Room or UPB Units

To control individual lighting loads in a room, use the down arrow key to scroll through the list of units. When the unit is displayed, press the '#' key. For HLC/UPB lighting loads, the console will display:

```
LR Sconce
0=OFF 1=ON 2=DIM 3=BRT ↓
```

```
LR Sconce
4=LVL 6=LED 9=TIM #=STA↑
```

- Press 0 (OFF) to turn the selected lighting load off.
- Press 1 (ON) to turn the selected lighting load on.
- Press 2 (DIM) to dim the selected unit (1-9 steps, each step is 10% from its current level).
- Press 3 (BRT) to brighten the selected unit (1-9 steps, each step is 10% from its current level).
- Press 4 (LVL) to set the desired lighting level of the selected unit (0%-100%).
- Press 6 (LED) to turn on or off the LED behind the specified button on a general purpose 8-Button or 6-Button Keypad.
 - Specify 1-8 to control the LED behind buttons 1-8 respectively, and then select 0 (OFF) or 1 (ON).
- Press 9 (TIM) to time the selected unit (On, Off, Dim, Brighten).
 - Timed commands may be from 1-99 seconds, 1-99 minutes or 1-18 hours.
- Press # (STA) to see the exact status of a UPB device. When the '#' key is pressed, OmniPro II sends a "Status Request" message to the selected device for its current state. The exact state is then displayed.

```
LR Sconce
STATUS 67%
```

Note: When a UPB signal is received over the powerline, OmniPro II will automatically update the status of the device.

Controlling Centralite Units

```
Entry Lights
0=OFF 1=ON 2=DIM 3=BRT ↓
```

```
Entry Lights
4=LVL 5=RMP 9=TIM #=STA↑
```

- Press 0 (OFF) to turn the selected unit off.
- Press 1 (ON) to turn the selected unit on.
- 2 (DIM) does not affect Centralite units.
- 3 (BRT) does not affect Centralite units.

- Press 4 (LVL) to set the desired lighting level of the selected unit (0%-100%).
- 5 (RMP) does not affect CentraLite units.
- Press 9 (TIM) to time the selected unit (On or Off). Timed commands may be from 1-99 seconds, 1-99 minutes or 1-18 hours.
- Press # (STA) to see the status (On or Off) of a CentraLite device.

Controlling RadioRA Units

Entry Lights
0=OFF 1=ON 2=DIM 3=BRT ↓

Entry Lights
4=LVL 5=RMP 9=TIM #=STA↑

- Press 0 (OFF) to turn the selected unit off
- Press 1 (ON) to turn the selected unit on.
- 2 (DIM) does not affect RadioRA units.
- 3 (BRT) does not affect RadioRA units.
- Press 4 (LVL) to set the desired lighting level of the selected unit (0%-100%).
- 5 (RMP) does not affect RadioRA units.
- Press 9 (TIM) to time the selected unit (On or Off). Timed commands may be from 1-99 seconds, 1-99 minutes or 1-18 hours.
- Press # (STA) to see the status (On or Off) of a RadioRA device.

Note: When a RadioRA device transmits a signal (i.e. Switch or Dimmer is turned on or off locally, Mater Control button is pressed, or Phantom Button is executed), OmniPro II will automatically update the status of each affected device.

Controlling ALC or X-10 Units

Entry Lights
0=OFF 1=ON 2=DIM 3=BRT ↓

Entry Lights
4=LVL 5=RMP 9=TIM #=STA↑

- Press 0 (OFF) to turn the selected unit off.
- Press 1 (ON) to turn the selected unit on.
- Press 2 (DIM) to dim the selected unit (1-9 steps, each step is 10% from its current level).
- Press 3 (BRT) to brighten the selected unit (1-9 steps, each step is 10% from its current level).
- Press 4 (LVL) to set the desired lighting level of the selected unit (0%-100%).
- Press 5 (RMP) to ramp the lighting level of an ALC Dimmer Switch to a new level at a selectable ramp rate.
 - 5 (RMP) does not affect X-10 units.
- Press 9 (TIM) to time the selected unit (On or Off). Timed commands may be from 1-99 seconds, 1-99 minutes or 1-18 hours.
- Press # (STA) to view the current status of the unit.

Ramp Command (ALC)

When ALC Switch Modules are being used, it is possible to ramp the lighting level of an ALC Dimmer Switch to a new level at a selectable ramp rate. Only ALC Dimmer Switches respond to the Ramp command.

Press the 5 (RAMP) key to select the ramp command. The keypad will then prompt you for the desired ramp rate:

```
ENTER RATE:
MINUTES (1-99)  #=H/M/S
```

The rate specifies the time it takes the switch to go from full off to full on, or from full on to full off. Thus a level change from full off to 50% on will take half the time specified.

Before any digits are entered, the '#' key may be used to switch between specifying the rate in minutes, seconds, and hours. After you choose between minutes, seconds, and hours, enter the rate (2-99 seconds, 1-99 minutes, or 1-10 hours).

Next, enter a number (0-100) to indicate the final lighting level (intensity) desired.

```
LIGHTING LEVEL:
0-100%:
```

The keypad will beep and the lighting level will be adjusted. The keypad display top line will read:

```
Entry Lights 40% AT 1H
```

Controlling Compose Units

```
Entry Lights
0=OFF 1=ON 2=DIM 3=BRT ↓
```

```
Entry Lights
4=SCN 9=TIM      #=STA↑
```

- Press 0 (OFF) to turn the selected unit off.
- Press 1 (ON) to turn the selected unit on.
- Press 2 (DIM) to dim the selected unit (1-9 steps, each step is 10% from its current level).
- Press 3 (BRT) to brighten the selected unit (1-9 steps, each step is 10% from its current level).
- Press 4 (SCN) to set a group of lights to their predefined lighting levels.
- Press 9 (TIM) to time the selected unit (On or Off). Timed commands may be from 1-99 seconds, 1-99 minutes or 1-18 hours.
- Press # (STA) to view the current status of the unit.

Scene Command (Compose)

If Compose lighting switches are part of your installation, the Scene (SCN) command is used to set a group of lights to predefined lighting levels. There is an Off command, an On command, and 12 lighting scenes for each group of Compose lighting switches.

```
SCENE:
0=OFF 1=ON 2-13=A-L
```

Enter 0, followed by the '#' key, to turn the lights that are part of the selected group off. Enter 1, followed by the '#' key, to set the lights that are part of the selected group to predefined lighting levels.

To set the lights in the selected group to a predefined scene, enter the Scene number 2-13 (which corresponds to Scene A-L, respectively), followed by the '#' key. All lights that are part of the selected group are set to the predefined lighting levels for the selected Scene.

Timed Commands

The timed commands allow a units to be turned on or off for a specified period of time. The unit may be turned On for 1-99 (minutes or seconds), or 1-18 hours, then Off; or turned Off for 1-99 (minutes or seconds) or 1-18 hours, then On.

Lighting units (1-256) may also be dimmed or brightened for a specified period of time. The unit may be dimmed (1-9) steps for 1-99 (minutes or seconds), or 1-18 hours, then brightened back to its previous level; or brightened (1-9) steps for 1-99 (minutes or seconds), or 1-18 hours, then dimmed back to its previous level.

To enter a timed command, you must first enter the unit that you want to control. From the control menu, enter the unit number (or scroll to it using the arrow keys), then press the '#' key.

To enter a time, press the 9 (TIM) key. Before any digits are entered, the '#' key may be used to switch between minutes, seconds, and hours. After you choose, enter a time (1-99 for seconds & minutes, and 1-18 for hours). Once the time is entered, the control menu is redisplayed with the specified times shown.

For example:

```
Entry Lights      For 2H
0=OFF 1=ON  2=DIM 3=BRT↓
```

Status of a Unit

To see the status of a unit, from the control menu, press the '#' key. The last command along with any time (hh:mm:ss) remaining on a timed command will be displayed.

```
Entry Lights      1:22:10
STATUS ON
```

At this point, one of the menu choices may be entered or the '*' or '#' key may be pressed to redisplay the menu.

Note: If an X-10 signal is received over the powerline, OmniPro II will automatically update the status of the X-10 unit.

Internal Flags

The easiest way to define a flag is to refer to it as a "virtual relay". A flag can be in one of three separate states: On, Off, or set to a value between 0 and 255. If a flag has a value of 1-255, it is considered "On". If a flag has a value of 0 it is considered "Off". Flags are a powerful programming tool that can be used in several ways to accomplish advanced programming routines. Any Flag can also be used as a counter. Counters can be incremented, decremented, or set to a specific value (0 to 255).

When a counter is decremented to zero, the "When Unit Off" macro is executed. A counter will not decrement below zero. The counter will, however, roll over from 255 to 0 when incremented. The "When Unit Off" macro will be executed when the counter rolls over. This allows two counters to be cascaded to form a larger counter.

When the counter is incremented from 0 to 1, the "When Unit On" macro will now execute. This will allow you to execute a command when the Flag is incremented (counting up) from zero.

The Set command is used to set the counter to a value from 0 to 255. No macros are executed when the counter is set to zero or when the counter is changed from zero using the set command. This allows a counter to be reset without executing macros or programs associated with the counter counting to zero. Turn the Flag On or Off to have the associated macro execute. When the Flag is turned Off, its value is set to zero (0). When the Flag is turned On, its value is set to one (1). The counter is considered On for program conditions if it is nonzero (1-255).

Flags can be turned Off, On, Decrement (DEC), Increment (INC), Set, and Timed ON/OFF.

Controlling Outputs

The OmniPro II has eight outputs that can be used to switch relays. Outputs 1-8 are controlled as Unit Numbers 385-392, respectively. If the Interior Horn is configured as a "General Purpose" output, Unit Number 393 is used to control the output. If the Exterior Horn is configured as a "General Purpose" output, Unit Number 394 is used to control the output. In this configuration, Unit Numbers 393 and 394 should not be used as "Flags".

These 12 VDC voltage outputs are connected directly to the OmniPro II and not through a module. If you have something connected to these outputs, such as a sprinkler system, your dealer will explain its operation.

Outputs cannot be brightened or dimmed and are **not** affected by All ON or All Off commands.

All On / Off

The All On/Off menu is used to turn all unit numbers in the specified House Codes on and off.

Note: UPB, CentraLite, and RadioRA devices are not affected by the OmniPro II "All On" or "All Off" command. To achieve this functionality, we suggest the following:

UPB: Program a Link into each device that will respond to an OmniPro II "All On" and "All Off" command program. For example:

In each UPB switch that will respond to "All Off" and "All On", program a Link (in this example, Link 50 is used) that will go to 100% when activated (turned on). Then write the following programs in the OmniPro II controller:

```
WHEN ALL ON: LINK 50 ON
WHEN ALL OFF: LINK 50 OFF
```

CentraLite: Program the "All On" and "All Off" macro to execute an All On Scene and an All Off Scene on the CentraLite.

RadioRA: Program the "All On" and "All Off" macro to execute Phantom Button 16 (All On) and Phantom button 17 (All Off).

For example:

```
WHEN ALL ON: PHANTOM BUTTON 16 ON
WHEN ALL OFF: PHANTOM BUTTON 17 ON
```

This All On/Off menu is also used to control Leviton Scenes, RadioRA Phantom Buttons, UPB Links, and CentraLite Scenes. From the top-level display or from the main menu, press the 4 (ALL) key on the console keypad.

```
ALL
0=OFF 1=ON 2=SCN 3=LINK↓
```

```
ALL
4=PHANTOM 5=CENLIT ↓
```

All Lights On

At the ALL prompt, press the 1 (LIGHTS ON) key. The console will beep, and a command will be sent that turns on all specified X-10 and ALC units and HLC Rooms. X-10 Appliance Modules do not respond when the All Lights On command is sent. All House Codes (1-16), by factory default, respond to the All-On command.

NOTE: The All On function can be changed, if desired - **See Set Up Misc, All On And All Off.**

All Off

At the ALL prompt, press the 0 (OFF) key. The console will beep, and a command will be sent that turns off all specified X-10 and ALC units and HLC Rooms. All House Codes (1-16), by factory default, respond to the All-Off command.

NOTE: The All Off function can be changed, if desired - **See Set Up Misc, All On And All Off.**

Leviton Scene Control

OmniPro II supports Leviton Scene Control (a feature found in certain Leviton Switches). There are 256 Scenes that can be set and executed. The Leviton Switches are divided into "lighting groups" of four units each. Each of these lighting groups can be set to four different Scenes. Once the Scenes have been set up, a command can be sent to the units in that Scene to simultaneously return to the preprogrammed lighting level.

Scene

There are 256 Scenes that can be set and executed. The X-10 units (unit numbers 1-256) are divided into "lighting groups" of four units each. Each of these lighting groups can be set to four different Scenes. Scenes 1-4 apply to the first four unit numbers (units 1-4), Scenes 5-8 to the next four unit numbers (units 5-8), and so on. Thus an easy correspondence is made between Scene numbers and unit numbers.

		SCENES															
		1	2	3	4	5	6	7	8	9	10	11	12	13	14	15	16
UNIT NUMBERS	1	X	X	X	X												
	2	X	X	X	X												
	3	X	X	X	X												
	4	X	X	X	X												
	5					X	X	X	X								
	6					X	X	X	X								
	7					X	X	X	X								
	8					X	X	X	X								
	9									X	X	X	X				
	10									X	X	X	X				
	11									X	X	X	X				
	12									X	X	X	X				
	13													X	X	X	X
	14													X	X	X	X
	15													X	X	X	X
	16													X	X	X	X

X - Corresponds to the unit numbers in a Scene.

Scene Commands

Scene Commands are used to Set Scenes, issue a Scene On command, and issue a Scene Off command. To issue Scene Commands, press the 2 (SCENE) key. You are prompted to enter a Scene number.

```
ENTER SCENE :
1-256
```

Enter the Scene number (1-256) followed by the '#' key.

```
SCENE 1
0=OFF 1=ON 2=SET
```

Scene Set Command

The Scene Set command is used to set up Scenes for a lighting group. Set the desired lighting level for each of the units in the lighting group for the first Scene. The desired lighting level may be set manually at the switch, or by a command issued from the controller. After the desired lighting levels are set, press the 2 (SET) key to save the first Scene for that group. Commands are sent to each of the four units in that group to instruct each unit to save its current lighting level as the lighting level for the Scene. Repeat these steps to set up each of the remaining three Scenes for that lighting group.

Scene On Command

Once the Scenes have been set up, press the 1 (ON) key to command the four units in that Scene to return to the lighting level set by the Scene Set command for that Scene.

Scene Off Command

Once the Scenes have been sent, press the 0 (OFF) key to command the four units in that Scene to turn off.

Notes:

1. When sending Scene Commands, the controller must be configured to allow Extended Code transmissions on each House Code affected by a Scene.
2. The Scene Commands always apply to a group of four consecutive units, which are units 1-4, 5-8, 9-12, and 13-16 on a particular house code. You must address the units accordingly so that the desired units fall into the appropriate lighting groups.
3. The actual Extended Code Scene commands use a "group reference" that matches that sent by a Leviton Wall-Mounted Scene Controller set to the same address as the first unit in the lighting group. This allows wall-mounted controllers to be easily used for manual Scene selection.

UPB Links

In a UPB network, all control operations are done using Links. OmniPro II can transmit and receive up to 250 Links on the UPB network. Links are used to logically "connect" events on one or more devices to actions on one or more other devices. When two or more different devices share a common Link, they are said to be "linked" together. They can now communicate with each other over the powerline using the Link as a common identifier in all of their communications.

The power of Links is that you can "link" more than two devices together. For example, one keypad controller pushbutton can be linked to four UPB Wall Switches allowing the single press of that pushbutton to trigger all four lights to go to preset or absolute levels. In addition UPB Wall Switches allow for a preset light level and fade rate to be associated with each Link.

Activating and Deactivating Links

A special UPB command called "Link On" (activate) is used to command all of the devices that have the same Link to go to their preset light levels at their preset fade rates.

For instance, in our "All On" and "All Off" example, when "Link 50 On" is transmitted by OmniPro II, each UPB Wall Switch with Link 50 will go to 100% to achieve the "All On" effect. Other "Link On" (activate) commands may be transmitted that cause Wall Switch '1' to go to a desired level at a specified fade rate and Wall Switch '2' to go to a different level at a different fade rate. The ability to send more than one device to its preset level at a preset fade rate with a single command is known as activating a Link. Likewise, pressing a pushbutton on a 6-Button or 8-Button Keypad can send the "Link On" (activate) command.

A special UPB command called "Link Off" (deactivate) is used to command all of the devices that have the same Link to go to 0% at their preset fade rate. For instance, in our "All On" and "All Off" example, when "Link 50 Off" is transmitted by OmniPro II, each Wall Switch with Link 50 will go to 0% to achieve the "All Off" effect.

Setting a Link (Lighting Scenes)

Lighting scenes are created by pre-configuring light levels and fade rates in one or more UPB devices that get "activated" and "deactivated" by a Link command or button press on a 6-Button or 8-Button Keypad.

Each UPB Wall Switch can hold up to sixteen different preset light levels (0% - 100%) that can be "linked" to the OmniPro II controller or to a pushbutton on a 6-Button or 8-Button Keypad.

OmniPro II can "set" each of the 250 possible Links. The "Link Set" command is used to set up lighting scenes for a lighting group. To set a "lighting scene" using OmniPro II, adjust all of the UPB Wall Switches with the pre-configured Link to the desired lighting levels. The desired lighting levels may be set manually at the switch, or by a command issued from OmniPro II. After the desired lighting levels are set, the "Link Set" command can be transmitted by OmniPro II to save the new "light levels" for each of the devices pre-configured with the specified Link.

Executing Phantom Buttons

OmniPro II can turn on and turn off each of the 17 possible Phantom Buttons. Phantom Buttons must be pre-programmed into the RS-232 interface or Chronos. Phantom Button 16 is always assigned to “All On” (if the Phantom button is turned on or off) and Phantom Button 17 is always assigned to “All Off” (if the Phantom button is turned on or off).

To issue Phantom Button commands, from the top-level display or from the main menu, press the 4 (ALL) key on the console keypad, and then press the 4 (PHANTOM) key. You are prompted to enter a Phantom Button (1-17).

```
ENTER BUTTON :  
1-17
```

Enter the Phantom Button number (1-17) followed by the '#' key.

```
PHANTOM BUTTON 1  
0=OFF 1=ON
```

When a Phantom Button is turned on, all of the devices that are pre-programmed with that Phantom Button will go to their preset light levels. When a Phantom Button is turned off, all of the devices that are pre-programmed with that Phantom button will turn off.

Executing CentraLite Scenes

OmniPro II can turn on and turn off each of the 255 possible CentraLite Scenes. To issue CentraLite Scenes commands, from the top level display or from the main menu, press the 4 (ALL) key on the console keypad, and then press the 5 (CENLIT) key. You are prompted to enter a Scene (1-255).

```
ENTER SCENE :  
1-255
```

Enter the CentraLite Scene number (1-255) followed by the '#' key.

```
CENLIT SCENE 1  
0=OFF 1=ON
```

When a CentraLite Scene is turned on, all of the devices that are pre-programmed for that scene will go to their preset light levels. When a CentraLite Scene is turned off, all of the devices that are pre-programmed for that scene will turn off.

Buttons

A powerful feature of the OmniPro II is the ability to program **Buttons**. A Button (also known as macro) is a number on the keypad that is programmed to execute a series of commands when it is pressed. Buttons are used to program functions that are specific to your home and lifestyle.

Using a button, you can activate several commands at once. You can personalize 128 buttons with descriptive names. The following are some examples of programmed Buttons:

Leave for Work (Button 1):

- turn off all lights
- set thermostat to energy saving settings
- arm the security system in the Away mode

Go to Bed (Button 2):

- turn off all lights
- dim outdoor lights 20% to extend bulb life and reduce consumption
- arm security in Night mode

Dinner for Two (Button 3):

- dim the dining and living room lights
- turn on the porch light
- turn off all the bedroom lights
- dim the den light
- turn on the stereo

To activate a preprogrammed button, from the top-level display or from the main menu, press the 3 (BTTN) key on the console keypad. Select the button (macro) to be activated by using the arrow keys to scroll through a list of buttons, followed by '# '.

For extra convenience, event buttons are automatically activated when you change security modes, or when security zones open and close. This powerful feature allows you to set your system up so that control functions are performed when you arm your security system (such as turning off all lights and setting back the HVAC system). Door contacts and motion detectors can be used to turn on lighting automatically, then turn it off a few minutes after the person has left, and then only if it's dark.

Temperature Control

Your OmniPro II can control temperatures of your heating and cooling system, monitor the outside temperature, and detect high and low temperatures in special situations. Other appliances can be controlled by temperature as well - such as a bathroom heater or a ceiling fan.

The temperature menu is used to control HAI Communicating Thermostats, Programmable Energy Saver Modules, and Temperature Sensors. The status of each of these may also be displayed on the console.

HAI Communicating Thermostats and the Programmable Energy Saver Module (PESM) provides energy savings, comfort, and convenience by setting the HVAC system(s) to the proper temperature based on whether you are home, asleep, away, or vacation. The temperature can be reported as well as controlled over any telephone. A freeze alarm feature will cause a dial out if the temperature falls below a preset level.

The HAI Communicating Thermostats are digital heating and cooling thermostats that can be controlled by the user and by remote control. There are models for conventional single stage (gas or electric), heat pumps, and multi stage heating and cooling systems. All models offer programmability, stand-alone operation, and robust communication to the OmniPro II system.

HAI RC-Series Thermostats

The following control actions are allowed for HAI Communicating Thermostats:

- Set heating setpoints
- Set cooling setpoints
- Set system mode (Off / Heat / Cool / Auto)
- Set fan (On / Auto)
- Turn hold On and Off

NOTE: Not all actions are applicable to every type of thermostat.

To enter the temperature menu, from the top-level display or from the main menu, press the 5 (TEMP) key on the console keypad.

You will be prompted with the first named temperature zone (i.e. Upstairs). The temperature zone can be specified by entering the temperature zone number followed by the '#' key, or by pressing the arrow keys to scroll through the list of temperature zones. Press the '#' key when the desired temperature zone is shown.

Press the '0' key to select all HAI Thermostats. This is a simple way to broadcast the new Heat or Cool setting or change the system mode, fan mode, or hold mode of all HAI thermostats in your system. Temperature zones 1-64 are for HAI thermostats.

```
TEMPERATURE :  
ENTER TEMP ZONE  0=ALL ↓
```

After the '#' key is pressed, a menu appropriate for the type of temperature zone is shown. For Celsius temperatures, press the '#' key prior to entering the temperature to make the number negative. The Celsius temperature may also be specified in 0.5 degree steps, if three numeric digits are entered. The third digit adds a .5 to the first two digits, if it is anything other than zero. Enter a leading zero, if necessary.

For HAI heat/cool thermostats:

```
Upstairs  
1=MODE  2=HEAT  3=COOL ↓  
  
Upstairs  
4=FAN    5=HOLD  #=STAT ↑
```

To change the system mode on a thermostat, press 1 (MODE). A menu presenting options appropriate for that type of thermostat is then displayed. For heat/cool thermostats with auto changeover:

```
Upstairs MODE  
0=OFF   1=HEAT  2=COOL ↓  
  
Upstairs MODE  
3=AUTO                                     ↑
```

To change a temperature setting, press 2 (HEAT), 3 (COOL), or 2 (TEMP) as appropriate:

```
Upstairs HEAT  
ENTER TEMPERATURE :  
  
Upstairs COOL  
ENTER TEMPERATURE :  
  
Upstairs TEMP  
ENTER TEMPERATURE :
```

Enter the desired temperature then press the '#' key.

The fan control on a thermostat may be switched between on and auto by selecting 4 (FAN) from the temperature menu:

```
Upstairs FAN
0=AUTO  1=ON
```

Thermostats may be switched between hold mode and the normal run mode. While in hold mode, the thermostat does not respond to scheduled temperature changes but instead maintains the temperature at its current setting. The thermostat will then return to its scheduled operation setting once hold mode is removed.

The hold menu is used to control hold status of a thermostat. The hold menu is entered by selecting 5 (HOLD) at the temperature menu. Through this menu you may turn hold mode on and off.

For a heat/cool thermostat, the menu displayed is:

```
Upstairs HOLD
0=OFF   1=ON
```

Turn hold mode Off or On by selecting 0 (OFF) or 1 (ON), respectively.

For a heat/cool thermostat, the status shows the current temperature, the heating and cooling temperature setpoints, whether hold mode is on, the system mode, and the fan On/Auto selection.

```
Upstairs      TEMP: 78
HEAT: 70      COOL: 78  ↓

Upstairs
MODE: AUTO    FAN: AUTO ↑
```

If hold mode is On, "HOLD" is shown:

```
Upstairs      HOLD
MODE: AUTO    FAN: AUTO ↑
```

For a heat or cool thermostat, the status shows the current temperature, the temperature setpoint, whether hold mode is on, the system mode, and the fan on/auto selection.

```
Upstairs      TEMP: 71
HEAT: 70      ↓

Upstairs
MODE: HEAT    FAN: AUTO ↑
```

Programmable Energy Saver Modules (PESMs)

The PESH is used when you have any thermostat, other than a HAI Communicating Thermostat, and would like to control your heating and cooling system with the OmniPro II system. The PESH is a temperature sensor and control relay in a small enclosure that mounts near your central heating, ventilation, and air conditioning (HVAC) system thermostat. The PESH allows the OmniPro II to read the temperature of the area that the HVAC system controls. When you are away or asleep, the PESH can be set to allow the temperature to drift higher or lower to reduce the operating time, hence saving energy dollars.

The PESH provides an energy saver function. When the energy saver is on, the HVAC system is set back, meaning that the temperature is allowed to rise or fall to an energy saving level. When the energy saver is off, your thermostat operates normally. Your thermostat should be set to the desired comfort temperature. Only when the energy saver is on will the temperature be allowed to deviate from your normal thermostat setting.

There are three temperatures associated with each PESH:

Temperature - this is the air temperature read by the PESH.

Heat temperature - the air temperature will be allowed to fall to this temperature when the energy saver is on.

Cool temperature - the air temperature will be allowed to rise to this temperature when the energy saver is on.

The following control actions are allowed on PESMs:

- Turn Energy Saver On and Off
- Turn Energy Saver On and Off for a specified time
- Set heating setpoint
- Set cooling setpoint

You can turn the energy saver on, off, use a timed on/off, and change the Heat and Cool temperatures from the console or by telephone. Commands can also be programmed so that they occur by time schedule or by event, such as security mode change. For example, the system can be set up to turn the energy saver(s) On and make the Heat setback temperature 65 degrees and the Cool setback temperature 80 degrees when the alarm system is put in the Away mode. Another program can turn the energy saver(s) off (to resume normal operation of the HVAC system) at 4:30 P.M. on weekdays to make the house comfortable before arriving home. Different setback temperatures could be set for the Night mode.

NOTE: To set up your thermostat for use with a PESM, set it in the appropriate mode and set the temperature to your preference. Your heating and cooling system will always be off if you set your thermostat to Off mode. The PESM cannot turn it back on. The PESM cannot make your system cool below the thermostat's cool setting, or heat above the thermostat's heat setting.

Control actions for **temperature sensors:**

- Set low setpoint
- Set high setpoint

To enter the temperature menu, from the top-level display or from the main menu, press the 5 (TEMP) key on the console keypad. You will be prompted with the first named temperature zone (i.e. Upstairs). The temperature zone can be specified by entering the temperature zone number followed by the '#' key, or by pressing the arrow keys to scroll through the list of temperature zones. Press the '#' key when the desired temperature zone is shown.

```
TEMPERATURE ZONE :  
ENTER TEMPERATURE ZONE ↓
```

After the '#' key is pressed, a menu appropriate for the type of temperature zone is shown.

For Programmable Energy Saver Modules:

```
Upstairs  
0=OFF 1=ON 2=HEAT ↓
```

```
Upstairs  
3=COOL 4=TIME #=STAT ↑
```

For temperature sensors:

```
Upstairs  
2=LOW 3=HIGH #=STAT
```

To set a temperature setpoint, press 2 (HEAT) or 3 (COOL).

For Celsius temperatures, press the '#' key prior to entering the temperature to make the number negative. The Celsius temperature may also be specified in 0.5 degree steps if three numeric digits are entered. The third digit adds a .5 to the first two digits if it is any- thing other than zero. Enter a leading zero if necessary.

In additions to setpoint changes, an energy saver may be turned On or Off. It may also be turned On or Off for a specific duration.

To turn the energy saver Off, select 0 (OFF). To turn the energy saver On, select 1 (ON). To turn the energy saver On or Off for a specific duration, select 9 (TIME) prior to selecting On or Off. Enter the time as described under Control - Unit Commands.

```

Downstairs
0=OFF  1=ON  2=HEAT ↓

Downstairs
3=COOL  9=TIME  #=STAT ↑

ENTER TIME
MINUTES (1-99)  #=H/M/S

Downstairs      FOR 15M
0=OFF  1=ON      ↓

```

The current status of a temperature zone may be displayed by selecting ' #' (STAT) key from the main temperature menu. The status display differs depending on the temperature zone type.

When you are finished, press the '*' key twice to return to the top-level display.

IMPORTANT NOTES:

- There is a 3-minute minimum on and off time for PESMs designed to prevent short cycling your HVAC compressor. If the PESH has just turned the HVAC system on or off, it will wait 3 minutes before changing it, even though the display does change.
- If you change the Heat or Cool setback temperature on the PESH, the system will insure that there is always at least four degrees Fahrenheit difference between the Heat and Cool temperatures by altering the other setback temperature as necessary.
- PESMs are **NOT** affected by All On or All Off commands.

Freeze Alarms

Thermostats and PESMs can also be used to report potential freeze conditions before damage to pipes and appliances can occur. An alarm is activated when any Thermostat or PESH detects a temperature below 40 degrees. The alarm will not clear until the temperature exceeds 45 degrees.

When the alarm is initiated, the console beeper will be turned on and an alarm dial-out sequence will be initiated after the normal dial-out delay. Both voice and digital communicator dial-outs may be used. The voice dial-out will follow the Dial Order as specified in Set Up Dial. The digital communicator will report the Freeze Alarm Code to the Central Station.

The sounder is not activated for freeze alarms (this feature must be activated by your installer).

Indoor and Outdoor Temperature

The Model 31A00-1 Temperature Sensor is used for sensing temperatures from 0° F - 120° F and 31A00-7 Extended Range Temperature Sensor is used for sensing temperatures from -40° F - 120° F. It features a new, high accuracy temperature sensor that doesn't need calibration.

The temperature can be used to activate programs for controlling temperatures indoors and in attics, garages, greenhouses, basements, wine cellars, coolers, and freezers. The temperature can be displayed on the console or spoken over the telephone. It can also report, log, alert, or generate an alarm if the temperature reaches freeze conditions or if the temperature goes above the high setpoint or drops below the low setpoint programmed in the system.

Outdoor temperature zones have a High and Low temperature associated with them that can be used for control purposes. An example of this is to program the system to turn on the bathroom heat if the outdoor temp goes below 45 degrees. High and Low temperatures are changed the same way as a PESH.

When a temperature sensor is selected from the list of temperature devices, you may set a "Low" and "High" setpoint for activating programs or alarms. Enter the desired temperature then press the '#' key.

Upstairs
2=LOW 3=HIGH #=STAT

For negative temperatures (-1° to -40°), press the '#' key prior to entering the temperature to make the number negative. A Celsius temperature may also be specified in 0.5 degree steps if three numeric digits are entered. The third digit adds a .5 to the first two digits if it is any- thing other than zero. Enter a leading zero if necessary.

Outdoor Temperature

A Model 14A00 Outdoor Temperature Sensor is available which may be mounted outdoors to read the outdoor temperature. The zone used for the outdoor sensor is set up as an outdoor temperature zone type, rather than as a PESM zone type. When set up this way, the corresponding auxiliary output is not dedicated to the Model 14A00 and may be used for other purposes. Also, the outdoor temperature will not generate freeze alarms.

Outdoor temperature zones have a High and Low temperature associated with them that can be used for control purposes. An example of this is to program the system to turn on the bathroom heat if the outdoor temp goes below 45 degrees. High and Low temperatures are changed the same way as a PESM.

Temperature Control of Appliances

You can control appliances connected to X-10 and ALC modules (such as a ceiling fan) using Advanced Control Programming (ACP) of the OmniPro II. For example, the ceiling fan can be programmed to come on if the temperature goes above the High temperature.

High and Low setpoints for temperature zones are changed the same way as the PESM. However, on/off control of the ceiling fan is done from the 1 (CONTROL) menu. Use the ceiling fan's unit number to turn it On or Off. The PESM or Model 14A00 Temperature Sensor and the ceiling fan are linked together by an event button program.

Temperature Alarms

Temperature sensors can be used to signal that a temperature (in a special room, like a greenhouse or wine cooler) has gotten too high or too low. If the temperature in this zone goes above the High setpoint or below the Low setpoint, the console beeper is activated (inside and outside sirens are not activated) and the central station and/or voice dialer is called.

The High and Low setpoints are changed as described for the PESM. Use the zone number that the temperature sensor is connected to in place of the unit number.

NOTE: Setting a High or Low temperature to 0 takes it out of service.

Humidity

The Model 31A00-2 Indoor/Outdoor Temperature and Humidity Sensor is used for sensing indoors temperature and/or reporting the relative humidity from 0 to 100 percent or for sensing the outdoor temperature and/or reporting the outdoor relative humidity.

High and low humidity limits can be set for taking action (i.e. turning on the bathroom vent fan, running a/c in de-humidification mode, turning on humidifier in heating mode, etc.) or reporting high or low humidity conditions in homes, greenhouses, wine cellars, coolers, humidors, etc. Controlling humidity is particularly helpful in combating the growth of mold in vulnerable areas of the home, such as bathrooms, basements, attics, etc.

The humidity level (0-100%), the low humidity setting, and high humidity setting can be viewed and modified using the temperature menu. To enter the temperature menu, from the top-level display or from the main menu, press the 5 (TEMP) key. The humidity zone can be specified by entering the zone number followed by the '#' key, or by pressing the arrow keys to scroll through the list of temperature and humidity zones. Press the '#' key when the desired temperature zone is shown.

INDOOR: HUMI: 75
LOW: 10 HIGH: 90

Status

The Status function is used to display the status of various items in the system. To enter the status menu, from the top-level display or the main menu, press the 6 (STATUS) key on the console keypad.

```
STATUS
1=CTRL  2=ZONE  3=SUN  ↓
4=TEST  5=TEMP  6=ENERGY
                                     ↑
```

1 = CTRL (CONTROL UNITS)

The Control Status menu allows you to view and scroll through the status of each control unit and to configure HLC and UPB devices. To enter the Unit menu, from the Status menu, press the 1 (CTRL) key in the console keypad. The system will display:

```
DEN LAMP
STATUS  OFF  ↓
```

You may enter a unit number to start displaying the status of that unit, or simply press the down arrow key to scroll through the list of units. The status display is as shown under Control, except that now the arrow keys may be used to continue scrolling between units.

```
Porch Light      00:24:19
LAST COMMANDED  ON      ↓
```

You can also check the state and (if any) the remaining time duration of any Unit.

At this point, you may press the ' #' key to control the unit as specified under Controlling Units or press ' ## ' to configure and HLC or UPB device.

Note: Only HAI manufactured UPB™ devices (collectively referred to as HLC devices) can be configured using an OmniPro II controller. Other UPB™ devices may be used, but cannot be configured using the OmniPro II controller; they must be configured using a PC running the UPB™ UPStart configuration software.

Configuring HLC Devices

HLC devices can be configured using an Omni console or OmniTouch touchscreen connected to the OmniPro II controller. When configuring HLC devices, the following information is programmed into the HLC device:

- Network ID (UPB Network ID configured in OmniPro II controller)
- Network Name (HAI Lighting)
- Unit ID (Unit Number of respective unit)
- Unit Name (which is the name description given to the respective unit in the OmniPro II controller)
- Room Name (using HLC, the name of the first unit in the respective group is used; otherwise the room number is used)
- Links (every device in each room is programmed with 6 consecutive Links, starting with Link 1; for example, every device in Room 1 is programmed with Links 1-6, Room 2 is programmed with links 7-12, etc.)
- Other configuration information

When configuring HLC devices using an Omni console or OmniTouch touchscreen, each device (unit number) must first be assigned a name in the OmniPro II controller. HAI recommends that you first configure your OmniPro II controller (naming all of the HLC units) using the HAI PC Access Software, and then download the information to the OmniPro II controller.

Configuring HLC Devices using an Omni Console

To configure HLC devices from an Omni console, use the Status menu. To enter the Status menu, from the top-level display or the main menu, press the 6 (STATUS) key on the console keypad.

```
STATUS
1=CTRL  2=ZONE  3=SUN  ↓
```

Press 1 (CTRL) to view the current status of each unit and to configure the HLC device that is assigned for each unit. The console will display:

```
Porch Light
STATUS OFF          ↓
```

You may enter a unit number to display the selected unit, or simply press the down arrow key to scroll through the list of named units.

When the desired unit is displayed, put the selected HLC device into Setup Mode (**See - Setup Mode for HLC Devices**), and then press the '#' key twice (i.e. ##). The display will provide you with step-by-step configuration status. When complete, the display shows:

```
CONFIGURE Porch Light
COMPLETED
```

Once completed, press the '#' key to return to the Status display and select your next unit (device). Put the next selected HLC device into Setup Mode (**See - Setup Mode for HLC Devices**) and then press the '#' key twice to configure the selected device.

Configuring HLC Devices using an OmniTouch Touchscreen

To configure HLC devices from an OmniTouch touchscreen, press the “Control” icon on the Home page. Select the desired unit from the Control list box to display the unit dialog. Put the selected HLC device into Setup Mode (**See - Setup Mode for HLC Devices**), and then press the “Config” button.

The display will provide you with step-by-step configuration status. Once completed, press the Exit icon.

Setup Mode for HLC Devices

To configure HAI UPB™ Wall Switches and Dimmers, put the device in Setup mode as follows:

Step	Operation
1	Tap the rocker switch quickly 5 times.
2	The HAI UPB™ Wall Switch or Dimmer will flash the lighting load one time and blink its LED blue to indicate that it is in Setup Mode. Note: The switch will automatically exit Setup mode after 5 minutes. To manually exit Setup mode, tap the switch quickly 2 times.

To configure the HAI UPB™ 6-Button Room Controller, put the device in Setup mode as follows:

Step	Operation
1	Press and hold the “ON” and “OFF” pushbuttons simultaneously for at least 3 seconds.
2	All of the LED indicators will blink to indicate that the HAI UPB™ 6-Button Room Controller is in Setup Mode. Note: The HAI 6-Button Room Controller will automatically exit Setup mode after 5 minutes. To manually exit Setup mode, press and hold the “ON” and “OFF” pushbuttons simultaneously for at least 3 seconds.

To configure the HAI UPB™ 8-Button House Controller, put the device in Setup mode as follows:

Step	Operation
1	Press and hold the “1” and “8” pushbuttons simultaneously for at least 3 seconds.
2	All of the LED indicators will blink to indicate that the HAI UPB™ 8-Button House Controller is in Setup Mode. Note: The HAI 8-Button House Controller will automatically exit Setup mode after 5 minutes. To manually exit Setup mode, press and hold the “1” and “8” pushbuttons simultaneously for at least 3 seconds.

Note: When OmniPro II finishes configuring the device, it will automatically exit Setup mode and return to normal operation.

2 = ZONE

The Zone Status menu allows you to view and scroll through the status of each zone input. To enter the Zone menu, from the Status menu, press the 2 (ZONE) key on the console keypad. The system will display:

```
Front Door      SECURE
ZONE 1          ↓
```

You may enter a zone number to start displaying the status with zone, or simply press the down arrow key to start with the first zone. The arrow keys may be used to continue scrolling between zones. For each zone, the display will show the zone name, the zone number, and the current status of the zone:

3 = SUN (SUNRISE / SUNSET AUTOMATIC CALCULATION)

The system automatically calculates the time of sunrise and sunset each day. From the status menu, press the 3 (SUN) key on the console keypad to display the calculated time of sunrise, sunset, and the outdoor temperature (if outdoor temp sensor installed):

```
Sunrise: 6:00 AM   Temp
Sunset:  5:58 PM   85
```

4 = TEST (SYSTEM DIAGNOSTIC TEST)

The diagnostic test performed by the OmniPro II allows you to check the status of the battery, telephone, bell circuit, auxiliary fuse, and security zone loop readings. The display is updated 3 times per second, although the actual readings are taken 10 times per second. To enter the Test menu, from the Status menu, press the 4 (TEST) key on the console keypad.

The first display shows the current battery reading and the phone line status. A battery test is initiated when the status mode is first entered. The new battery reading is updated ten seconds later. The low battery limit is also displayed.

The phone status consists of two parts, separated by a "/". The first part shows the current phone line state:

```
ONHK - ON HOOK           OFFHK - OFF HOOK
RING - RINGING          DEAD - DEAD PHONE LINE
```

The second part shows how the OmniPro II is currently using the phone line:

```
IDLE   - NOT USING THE PHONE LINE
LOCAL  - LOCAL ACCESS
REMOTE - REMOTE ACCESS
VOICE  - IN VOICE DIAL OUT MODE
EMGACC - ACCESS AFTER VOICE DIAL OUT
DCM    - IN DIGITAL COMMUNICATOR MODE
```

```
BATTERY: 230 (LIMIT 200)
PHONE:   ONHK/IDLE      ↓
```

Next, the display shows the A/D reading for the battery voltage, phone line voltage, AC power on, bell, and fuse:

```
BAT:  225   PHONE: 140
ACON:  82   BELL:  215 ↓
FUSE:  222                                     ↓
```

The next series of displays shows the current analog reading for each security zone input. The displays show the readings for zones 1-176.

1=147 2=148 3=147
4=146 5=146 6=147 ↓

THROUGH

175=148 176=147
↑

Normal readings for zones are between 137 - 157 when secure. If Zones 1-4 are configured as Fire or Gas zone, normal readings are between 26 - 43 when secure. Each reading should be changing only by two or three counts from its average steady reading. When a door or window is opened, the reading will go up to a value that represents that zone is open.

This feature can be used to monitor the quality of the zone wiring and contacts. If the numbers begin to deviate from their original values when the system was new, wiring problems that will eventually lead to trouble or false alarms may be developing. You may wish to record the Status Test values for future reference.

5 = TEMP (TEMPERATURE)

The Temperature Status menu allows you to view and scroll through the status of each Thermostat, PESM, and Temperature Sensor. To enter the Temperature menu, from the Status menu, press the 5 key on the console keypad. The system will display:

TSTAT 1 TEMP: 80 ↓
HEAT: 60 COOL: 82

You may enter a unit number to start displaying the status with that unit, or simply press the down arrow key to scroll through the list of temperature zones. The status display is as shown under Temperature Control, except that now the arrow keys may be used to continue scrolling.

TSTAT 1
MODE: AUTO FAN: AUTO ↓

At this point, you may press the '#' key to control the temperature zone as specified under Temperature Control.

6= ENERGY (ENERGY COST)

The Energy Cost Status menu allows you to view the current energy rate in use.

ENERGY COST: MID

The Energy Cost will display Lo, Mid, Hi or Crit (for critical) energy rates.

Event Log

The Event Log records the 250 most recent significant security system Events (happenings) and trouble conditions in the system. When a new event occurs, the oldest one is lost.

The following Events, along with the time and date of their occurrence are recorded in the Event Log when they occur:

- All Security system Armings and disarmings (Off, Day, Night, Away, and Vacation), and user name.
- All zones bypassed or restored by the user, and user name.
- Any zone automatically bypassed by the system.
- Any zone tripped while the security system is armed.
- Any trouble condition (zone, battery, fuse, AC power, or phone).
- The restoration of any trouble condition (the trouble condition ceased to occur).
- Any Remote Telephone Access, Remote Access Denied, or Remote PC Access.

Show Events

To view your event log, from the top-level display or from the main menu, press the 7 key, then enter your code. The arrow keys may be used to scroll through the event log, starting with the most recent event.

Each event log entry displays the time and date on the top line and a description of the event on the bottom line:

```
7:15 PM 5/8
USER NAME      AWAY
```

For trouble conditions, the event log will show the zone name or specific trouble condition and "TROUBLE":

```
10:59 AM 5/8
BATTERY      TROUBLE
```

For trouble restorations, the event log will show the zone name or specific trouble condition and "TRBL RST":

```
11:57 AM 5/8
BATTERY      TRBL RST
```

The system records each remote access. A remote phone access is when someone calls into the system from an outside phone line. Remote phone access is also recorded if the system phones out in response to an alarm and the called party enters a code. The event log displays the code used to access the system and "REM ACCESS":

```
12:05 PM 5/8
USER NAME      REM ACCESS
```

An event is logged after three unsuccessful attempts are made to log into the system from a remote phone, the OmniPro II will lock out remote telephone access for 1 hour to discourage any further attempts to access the system - **See Telephone Control**.

Local access of the system using an in-house telephone is not recorded.

The event log will also record each time the PC Access software is used to access the system. The event log displays the code used to access the system and "PC ACCESS".

Messages

The Message menu is used to play and record the memo message and to quickly clear all text messages. The memo message is an eight-second voice message. It's like an "electronic notepad" for a family member to leave a handy message. After a message is recorded, it can automatically be played back when someone returns and disarms the security system.

The Message menu is also used to show, log, clear, and send text messages, and to say and phone (dial out) your voice messages.

To enter the Message menu, from the top-level display or from the main menu, press the 8 (MESSAGE) key on the console.

```
MESSAGE
1=PLAY 2=RECORD 3=CLEAR↑
8=MESSAGE
↑
```

Record Memo Message

Note: To *Record* the memo message using this key, the HAI Two-Way Audio Module (with a microphone) must be installed.

To record a new voice memo message, press the 2 (RECORD) key.

OmniPro II will say, "Record Message". At the beep, record your eight-second message. OmniPro II will beep a second time at the end of the eight seconds, which signifies the end of the record process.

After a new message is recorded, the display will show "CHECK MESSAGE".

Play Memo Message

Note: To *Play* the memo message using this key, the HAI Two-Way Audio Module (with a speaker) must be installed.

To play the voice message, press the 1 (PLAY) key.

Over the speaker, OmniPro II will say, "Message is" - OmniPro II will then play your eight-second message.

- OmniPro II will automatically play a new memo message when the security system is disarmed.
- After the message has been played, the display will no longer show "CHECK MESSAGE".

Clear Text Messages

If any text messages are currently being displayed on the console, they can be deleted by pressing the 3 (CLEAR) key.

When you press the 3 (CLEAR) key, all messages are cleared from the console display.

Message

To show, log, clear, and send text messages, and to say and phone (dial out) your voice messages, press the 8 (MESSAGE) key:

```
MESSAGE
1=SHOW 2=LOG 3=CLEAR↓
4=SAY 5=PHONE 6=SEND
↑
```

Show Message

The 1 (SHOW) key allows you to display the selected text message(s) on the console's top-level display. This can be a helpful reminder of special events and occasions.

```
TRASH NIGHT
ENTER MESSAGE      ↓
```

You may enter the message number followed by the '#' key to display that message, or simply press the down arrow key to scroll through a list of messages. Press the '#' key to display the selected message:

```
Thu Oct 04, 01    4:06 PM
TRASH NIGHT
```

When the message is displayed, the console will beep 4 times and the console LED will flash continuously. You may press the '*' key to acknowledge seeing the message. This will cause the LED to stop flashing, however, the message will remain on the display until it is manually cleared, or cleared by a program.

Log Message

The 2 (LOG) key allows you to store the selected text message(s) in the Event Log. This can be a helpful to keep track of the times and dates of events and occurrences.

You may enter the message number followed by the '#' key to log that message, or simply press the down arrow key to scroll through a list of messages. Press the '#' key to log the selected message.

Clear Message

The 3 (CLEAR) key allows you to clear the selected text message, or all text messages from the console's display.

```
TRASH NIGHT
ENTER MESSAGE    0=ALL ↓
```

You may enter the message number followed by the '#' key to clear that message, or simply press the down arrow key to scroll through a list of messages. Press the '#' key to clear the selected message, or press 0, then '#' to clear all messages.

Say Message

Note: To Say a message, the HAI Two-Way Audio Module (with a speaker) must be installed.

The 4 (SAY) key allows the controller to say the selected voice message over a speaker. This voice message can be an audible reminder of special events and occasions.

You may enter the message number followed by the '#' key to say that message, or simply press the down arrow key to scroll through a list of messages. Press the '#' key to say the selected message.

Phone Message

The 5 (PHONE) key allows the controller to call the selected phone number and say the selected voice message.

```
PHONE NUMBER :
1 - 8
```

Select a phone number (1-8) from the dial menu, then press '#' :

```
SECURITY OFF
ENTER MESSAGE      ↓
```

You may enter the message number followed by the '#' key, or simply press the down arrow key to scroll through a list of messages. Press the '#' key to dial the number and say the selected voice message.

Send Message (Pro-Link)

The 6 (SEND) key allows you to send any of the text messages through the Pro-Link serial port. You are first prompted to specify the desired serial port.

```
SERIAL PORT :  
1 - 4
```

The built-in serial ports (J1-J3) on the controller are assigned to Serial Port 1 - Serial Port 3, respectively. Serial port 4 is a Serial Interface Module connected to the Expansion port on the controller.

Next, select the message to be sent. You may enter the message number followed by the '#' key to send that message, or simply press the down arrow key to scroll through a list of messages. Press the '#' key to send the selected message:

```
MSGNAME  
ENTER MESSAGE :      ↓
```

The message is sent out through the specified Pro-Link port exactly as the message was entered in *Setup / Names / Message*.

Carriage returns and line feed characters are not automatically appended to the end. To send ASCII control as part of the message, use the caret "^" character in the message. This character specifies that the next character is to be interpreted as an ASCII control character, such as "^M" to represent a carriage return.

Other useful sequences would be "^J" for a line feed character and "^G" for a bell character. To include an actual "^" character in the message, enter it twice as in "^^".

Each message can be up to 15 characters long. To send a longer message, simply program two messages to be sent one after the other.

Pro-Link also has the capability to monitor the serial port for incoming text messages. When a text message is received, Pro-Link searches through all 128 messages for a matching message. If one is found, the Program Command (macro) corresponding to the matching message is activated.

When receiving an ASCII message that is over 15 characters, OmniPro II only processes the last 15 characters of the message.

Pro-Link determines that a message has been received when:

- One or more characters have been received followed by 100 ms of silence
- One or more characters followed by a carriage return character are received
- One or more characters followed by a line feed character are received

It is not necessary to enter the terminating carriage return or line feed character as part of the message name.

TELEPHONE CONTROL

Telephone Interface

Your OmniPro II is equipped with a built-in telephone response feature that allows you to control and access the status of your system from any Touch-Tone phone.

The OmniPro II actually talks to you using a digital recording of an actual human voice, so the sound is incredibly life like. You send commands to the OmniPro II using the keys of your Touch-Tone telephone. There are no tapes, discs, or other moving parts associated with the speech and control features, so there is no maintenance or parts to wear out.

Only Touch-Tone phones will work with the OmniPro II. Some phones have switches that allow you to select Pulse or Tone. Set them to Tone to work with the OmniPro II.

NOTE: There are two keys on your Touch-Tone telephone that are special. The ' #' key (pound key, to the right of the zero), and the '* ' key (star key, to the left of the zero). You will be using these keys.

In-House Phones

Each time you pick up your telephone at home, the OmniPro II will also pick up the line and listen for a # (pound) key. If OmniPro II does not hear the # key within 5 seconds, it hangs up and does not listen in again until the next time you pick up your phone. If the OmniPro II hears any key other than the # key while it is listening in, it disconnects itself immediately.

If the OmniPro II does hear the # key within 3 seconds of your picking up the receiver, it disconnects your phones from the phone company lines and connects your phones to itself, and begins talking to you. When you hang up, your phones are immediately reconnected to the phone company.

You will hear a slight click on your phone when the OmniPro II picks up or hangs up. This is normal. To access your OmniPro II from an in-house phone: Pick up the receiver of any Touch-Tone phone in your house. Pause for just a moment (about a second), then press the # key on the phone.

You will hear the voice read the menu, which tells you what commands are available over the telephone.

NOTE: If your system is in High Security Mode, you must also enter your code following the # key - **See High Security Mode.** In UL Listed Installations, High Security Mode is enabled.

If the alarm system is tripped, the in-house phones will be disconnected when the OmniPro II begins to dial out, to preclude a burglar from jamming the line by shorting out an in-house phone. In this case, you will have to turn the system off at the console.

Remote Phones

You may call your system from any Touch Tone phone and "talk" to your OmniPro II, exactly as if you were at home, except that you must enter your code (Master or Manager) to gain access to the OmniPro II.

To call your system from any touch tone phone, call your number. After 8 rings (or whatever you have "Rings Before Answer" set to) your OmniPro II will answer and "beep" - See *Set Up Dial*. Press the digits of your code on the phone. The first digit must be pressed within 3 seconds of the beep. You will hear the menu.

If you hear three beeps after entering the code, you have entered the wrong code. Try again. If you make a mistake while entering the code, press the # key and then enter the code again. You only have three tries to enter a valid code.

A successful remote access is logged in the event log as a Remote Phone Access, along with the time, date of its occurrence, and the code number used.

There are a number of setup items that control what you can do from a remote phone when you or anyone else calls into your home - **See Set Up, Dial.**

Phone Access Denied - Remote Lockout

The OmniPro II has a remote lockout feature to discourage youngsters (and adults who act that way) from trying to access your system. If four invalid codes are entered, the system will hang up and a one-hour lockout period will begin. During the lockout period, the OmniPro II will not answer a call after any number of rings, which should discourage the caller.

If a lockout occurs, the event Phone Access Denied is entered into the event log, along with the time and date of its occurrence.

The one-hour lockout does not apply to in-house phones. The lockout is cleared immediately if the OmniPro II is accessed using an in-house phone.

Alternate Method

The OmniPro II has an alternate access method that may be more effective, especially when calling long distance.

1. Call the system and allow the phone to ring once or twice.
2. Hang up.
3. Wait about 10 seconds, but within 60 seconds, call the system again. It will answer on the first ring and beep.
4. Enter your code.

Main Menu

Once you have successfully logged into your OmniPro II, it will read you a menu of commands, as follows:

WELCOME TO OMNIPRO [AREA 1] PLEASE CHOOSE:

- 1: CONTROL
- 2: SECURITY
- 3: BUTTON
- 4: ALL
- 5: TEMPERATURE
- 6: STATUS
- 7: EVENT
- 8: PHONE
- 9: GOOD-BYE
- *: CANCEL
- 0: REPEAT

This means that you press '1' for Control functions, '2' for Security, '3' for Button, etc. Pressing one of the keys on the phone will move you to another menu. These menus are the same as the menus on the console. Words in brackets [] are only spoken if that feature is in use.

You do not have to wait for the OmniPro II to finish talking. Once you are familiar with the menus, you can simply punch the numbers on the phone without waiting. Whenever you press a number, the OmniPro II stops talking and goes on to the function that you have selected. If you press a key that is not on the current menu, you will hear 3 beeps and the menu will be repeated.

So that the OmniPro II does not tie up your phone, there is a 10 to 15 second time-out that starts after the OmniPro II stops talking. If it does not hear any numbers from your phone in 10 to 15 seconds after it stops talking, the OmniPro II will hang up. If you are on a remote phone and the OmniPro II hangs up, you must call the OmniPro II again. If you are on an in-house phone, hang up, wait a few seconds, then pick up and press the # key.

To hear the main menu again, press 0 on your phone. To cancel an operation, press '*' for Cancel. You will hear "CANCEL" and one beep for a cancel operation.

If you make a mistake, you will hear 3 beeps, then the OmniPro II will re-read whichever menu you are in.

1 - Control

Press 1 from the MAIN MENU to get to the CONTROL menu.

If voice descriptions have been programmed, after a three-second delay, the system will begin reading from the list of units (OmniPro II will say the unit number then its description). The OmniPro II will read three units, then say,

"PRESS POUND TO CONTINUE."

If the '#' key is pressed, OmniPro II will read the next three unit numbers and descriptions (if programmed).

2 - Security

Press 2 from the MAIN MENU to get to the SECURITY menu.

From the Security menu you can arm your system (Day, Night, Away, Vacation, Day Instant, and Night Delayed), disarm you system, bypass and restore zones, and go to a different area.

When bypassing and restoring a zone, if voice descriptions have been programmed, after a three-second delay, the system will begin reading from the list of zones. If the '#' key is pressed, OmniPro II will read the next three descriptions (if programmed).

GOTO Area

Press the # key to GOTO a different area. OmniPro II will say:

"GOTO AREA: ENTER AREA THEN #." "ENTER CODE, *: CANCEL"
"WELCOME TO OMNIPRO II, AREA 2."

3 - Button

Press 3 from the MAIN MENU to get to the BUTTON menu.

If button voice descriptions have been programmed, after a three-second delay, the system will begin reading from the list of buttons (OmniPro II will say the button number then its description).

User buttons 1 - 128 are available from the phone, for the current area.

4 - All

Press 4 from the MAIN MENU to get to the ALL menu.

"ALL: PLEASE CHOOSE:"
0: ALL OFF
1: ALL ON
2: LIGHT SETTING (Leviton Scene)

5 - Temperature

Press 5 from the MAIN MENU to get to the TEMPERATURE menu. The OmniPro II will say,

"TEMPERATURE: ENTER TEMPERATURE NUMBER, THEN POUND."

After a three second delay, the system will begin reading from the list of Thermostats and Energy Savers (if voice descriptions have been programmed, OmniPro II will say the temperature zone then its description). The OmniPro II will read three temperature zones, then say,

"PRESS POUND TO CONTINUE."

If the '#' key is pressed, OmniPro II will read the next three temperature zones and descriptions (if programmed).

Press the temperature zone you wish to control, then press #.

Press the '0' key to select all HAI Thermostats. This is a simple way to broadcast the new Heat or Cool setting or change the system mode, fan mode, or hold mode of all HAI thermostats in your system.

When an HAI Communicating Thermostat is entered:

"THERMOSTAT 1 - THERMOSTAT 1 - TEMPERATURE IS (TEMP)."

"PLEASE CHOOSE:

- 1: MODE
- 2: HEAT SETTING
- 3: COOL SETTING
- 4: FAN
- 5: HOLD
- #: STATUS
- *: CANCEL

- If the # (STATUS) key is selected, OmniPro II will read the current status of the thermostat. For instance:

"TEMPERATURE IS (80), HEAT SETTING IS (60), COOL SETTING IS (75),
MODE IS (COOL), FAN IS (AUTO), HOLD IS (OFF)."

When a Programmable Energy Saver (PESM) is entered:

"ZONE 9 ENERGY SAVER - ENERGY SAVER IS (ON/OFF).
TEMPERATURE IS (TEMP)."

"PLEASE CHOOSE:

- 0: OFF
- 1: ON
- 2: HEAT SETTING
- 3: COOL SETTING
- 9: TIMED
- #: STATUS
- *: CANCEL

- If the # (STATUS) key is selected, OmniPro II will read the current status of the PESM. For instance:

"ENERGY SAVER IS (ON/OFF): TEMPERATURE IS (80), HEAT SETTING IS (60), COOL SETTING IS (75)."

6 - Status

Press 6 from the MAIN MENU to get to the STATUS menu.

From the Status menu, OmniPro II will report the Security Mode (for the current Area).

If all zones are secure and there are no troubles with the system, OmniPro II reports "System OK".

If any zones are currently not ready, in trouble, or bypassed, OmniPro II will report the current status of those zones. Any system troubles are also reported.

Finally, OmniPro II will report the current Outdoor Temperature (if part of the system) and the current time and date.

7 - Events

Press 7 from the MAIN MENU to get to the EVENT menu.

The OmniPro II will read the 3 latest events. Press the '7' key for OmniPro II to read 3 more events, or '*' to cancel.

8 - Message

This command allows you to record and verify the voice memo message, allows you to record and play custom messages (phrases), and allows you to record and verify your address. If an optional HAI Two-Way Audio Module is being used, this command also allows paging and listening to the premises.

Press 8 from the MAIN MENU to get to the MESSAGE menu.

"MESSAGE - PLEASE CHOOSE: 1 PLAY MESSAGE, 2 RECORD MESSAGE, 3 INTERIOR, 6 PLAY PHRASE, 7 RECORD PHRASE, 8 PLAY ADDRESS, 9 RECORD ADDRESS, *: CANCEL."

To play the current address, press the 8 key.

Playing and Recording a Message

To play the current message, press the 1 key.

"MESSAGE IS: (OMNIPRO II PLAYS MESSAGE)."

Note: When OmniPro II is playing the message or the address, it does not listen for Touch-Tones.

To record the memo message, press the 2 key.

"RECORD MESSAGE - [BEEP]

At the [BEEP], record your message...

At the second [BEEP]:

"MESSAGE IS: (OMNIPRO II PLAYS MESSAGE)."

Paging and Listening

When the HAI Two-Way Audio Module is being used:

To talk or listen to the premises, press the 3 key.

"PLEASE CHOOSE: 2 TALK, 8 LISTEN, *: CANCEL."

- If no key is pressed, OmniPro II will automatically switch to listen mode.

To talk to someone at the premises, press the 2 key.

To listen to the premises, press the 8 key.

- You cannot talk to anyone on premises in listen mode and you cannot listen to the premises while in the talk mode.

Playing and Recording a Custom Phrase

When you can't find a word you need to complete a voice description or voice message, you have the ability to record a custom phrase in OmniPro II. This phrase can then be used as part of your voice description and spoken over the telephone along with the item number that is normally spoken. It can also be part of your voice descriptions for a message that is spoken over a speaker in your home or business.

Phrases 1-32 are unique two-second phrases. Phrases 33-48 are four-second phrases that are made up of 2 two-second phrases. Phrases 49-56 are eight-second phrases that are made up of 4 two-second phrases. Phrases 57-60 are sixteen-second phrases that are made up of 8 two-second phrases.

For a complete list of Phrases and Voice Descriptions, including a complete description of Custom Phrases - *See Appendix C Voice Description Codes and Notes on Custom Phrases* in this manual.

To play one of the custom phrases, press the 6 key.

"PLAY PHRASE: ENTER PHRASE NUMBER, THEN POUND."

Press the phrase number (1-60) you wish to play, then press #.

"PHRASE IS: (OMNIPRO II PLAYS PHRASE)."

To record one of the custom phrases, press the 7 key.

"RECORD PHRASE: ENTER PHRASE NUMBER, THEN POUND."

Press the phrase number (1-60) you wish to record, then press #.

"RECORD PHRASE - [BEEP]"

At the [BEEP], record your custom phrase...

At the second [BEEP]:

"PHRASE IS: (OMNIPRO II PLAYS PHRASE)."

Playing and Recording the Address

To record the address, press the 9 key and enter the Master code.

"RECORD ADDRESS - [BEEP]"

At the [BEEP], record your name and address.

"ADDRESS IS: (OMNIPRO II PLAYS ADDRESS)."

Note: The address is used only for the VOICE dial out feature.

9 - Good-Bye

Press 9 from the MAIN MENU.

The OmniPro II will say, "GOOD-BYE" and hang up.

From an in-house phone, the dial tone will return. From a remote phone, you will hear a click as the OmniPro II hangs up. It is recommended that you press 9 to terminate a remote call. If you don't, the OmniPro II will hang up anyway after about 15 seconds.

Panic Button over the Phone (#####)

On an in-house phone only, you can activate the Police Emergency keys by picking up the phone and pressing the # key 6 times. This activates the sounder immediately.

The first # that you press logs you in, as usual, then the next 5 presses of the # key activate the alarm. If you are already logged into your system, then it takes only 5 presses of the # key to activate the emergency alarm. To prevent accidental activation of the panic feature over the phone, you must press the # key 5 times, all at once. If you pause for more than 2 seconds, or press any other key, the panic activation is canceled. The OmniPro II will say "CANCEL".

Note that the Panic Button over the Phone feature only works if you are logged into the system. In an emergency, if you wish to set off the alarm, simply pick up the phone and repeatedly press the # key until the alarm sounds. Be aware that, under some circumstances, it may be smarter to dial 911 or your police department directly. Also be aware that your telephone will be unusable while the OmniPro II dials out.

Emergency Dial-Out

Emergency dial out consists of two distinct parts: the "digital dialer" and the "voice dialer."

Digital Dialer

The digital dialer (also called a "digital communicator") reports alarm events to a central station monitoring center. The digital dialer sends a digitally coded message to the central station's receiver and computer. The computer in the central station presents your name, address, and other information to a human operator who notifies the appropriate authorities.

Digital communications to a central station are generally superior to voice communications for three reasons:

- there is always someone manning the central station
- there is virtually no chance for misinterpretation
- personnel at the central station are trained to respond.

The digital communicator will not dial out until the Dial Out Delay has expired. If the alarm is canceled prior to the expiration of the Dial Out Delay, no transmission will take place. If the alarm is canceled after the Dial Out Delay has expired, all alarm trips will be transmitted followed by a Cancel code.

The communicator may be set up to automatically send a test code to the central station on a daily or weekly basis. This verifies proper operation of the entire monitoring system on a periodic basis.

When the digital communicator is used, all voice dial outs will be delayed for five minutes after the expiration of the dial out delay to allow time for the central station to call the premises.

If the HAI Two-Way Audio Module is being used, after the transmission of the alarm to the central station, the operator can talk and listen to people and sounds at the premises.

If the digital communicator is unable to successfully communicate with the central station, the console will display a *Communicator Trouble* condition.

Voice Dialer

In UL Listed Installations, the Voice Dialer is supplementary to the Digital Dialer described above.

The voice dial-out feature of the OmniPro II is a sophisticated system that can notify you at the office, on vacation, on a pocket pager, or notify your neighbor, a relative, and in some cases, local authorities.

See *What Happens When the Alarm is Activated*, also *Set Up Dial*.

How the OmniPro II Voice Dialer Works

When a Burglar Alarm, fire alarm, police emergency keys, fire emergency keys, auxiliary emergency keys, gas alarm, water alarm, Temperature alarm, or duress alarm is activated, the voice dialer looks at the Dial Order to determine which numbers to dial and in what order. A Dial Order can have up to 8 entries, allowing the dialer to make up to 8 calls. If you want it to try a number twice, it can be entered twice in the dial order.

The dial order numbers can be chosen from Dial Out Numbers 1 - 8.

What the OmniPro II Voice Dialer Does

When an alarm is activated, the OmniPro II will wait the Dial Out Delay. If your system is monitored by a central station, it will be notified first. Then the voice dialer will dial out to the numbers as described above.

If the alarm is turned off at the console while a voice dial-out is in progress, the dial-out will be canceled immediately and the voice dialer will hang up. If the number dialed is busy, or if all lines are busy, the dialer will immediately hang up and go to the next number in the Dial Order. The dialer will wait up to 45 seconds after it finishes dialing a complete phone number for a voice to answer. If it doesn't hear a voice in that time, it goes on to the next number. The voice dialer will respond to answering machines.

After it has dialed the last number in the dial order, the OmniPro II stops dialing and reconnects the in-house phones.

What You Hear - If Your OmniPro II Calls You

When you pick up the phone and say something, the OmniPro II will say one of the following, depending on type of alarm:

- BURGLAR ALARM
- FIRE ALARM
- AUXILIARY ALARM
- TEMPERATURE ALARM
- WATER ALARM
- GAS ALARM
- SILENT ALARM

AND

- ADDRESS: (Your address here)
- PHONE NUMBER (your phone number here)

The OmniPro II will repeat this message twice.

Entering the Code

At any time during the message you can enter the Master or Manager code, simply by pressing the digits on the keypad of a Touch-Tone phone. The OmniPro II will stop talking when it hears *any digit* from a touch tone phone. (When it is saying the address, the OmniPro II completes the entire address before it stops talking.)

If you enter the correct Master or Manager code, you will then be logged in (a remote phone access is logged in the event log) and further dial outs are canceled.

You will hear the status of the system, which will describe the type of alarm and the zones tripped, for example:

BURGLAR ALARM ACTIVATED: ZONE 1 - ENTRY EXIT - TRIPPED; ZONE 3 - DAY INTERIOR - TRIPPED:

Then the OmniPro II will read the Main Menu as described in Telephone Control. You can press 0 to hear the menu. At this point, you are in control, just as if you had called your system.

A strategy to follow if you are called by your system is to check the Status (6 on the telephone) to see what mode the system is in, and which zones were tripped. Press * to cancel out of the status mode. You may wish to check the Event Log (7) to see when each event happened. Then, press * to exit the event log.

Now press 9 (good-bye) to make the OmniPro II hang up. Hang up your phone and call your premises to be sure that it wasn't someone who has forgotten their code. If not, call the police.

If someone properly disarms the system while the called party is logged in, then the status message will go back to "SECURITY MODE IS OFF - SYSTEM OK" as described in Telephone Control.

If a reportable event (an alarm, cancel, etc.) occurs while you are talking to your OmniPro II, it will hang up on you to communicate the event to the central station.

PC Access

OmniPro II is capable of communicating with an IBM compatible personal computer (PC). The PC can be local (in-house) or remote. The PC must be equipped with a modem or serial port and running PC Access software. The OmniPro II has a built-in modem and can be accessed over the telephone or over a direct serial connection (RS-232/RS-485 through either the built-in or optional serial interface module). If you wish to use your PC to configure, program, and check the status of your OmniPro II, contact your dealer for the appropriate software for your PC.

Built-In Ethernet Port

The built-in Ethernet port (J6) allows a device to connect to the OmniPro II controller via a network (i.e. Ethernet, Internet) using a secure, encrypted communication link. The Ethernet port transports HAI application-level packets containing Omni-Link serial protocol messages over IP. The controller supports 3 unique client “sessions” which means 3 devices may actively be connected and communicating with the controller simultaneously over the Ethernet port.

Controller IP Address, Port Number, and Encryption Key

The controller’s local IP address and port number set the local network parameters for the OmniPro II controller. The encryption key is used to establish a private, secure connection with the connected device.

These Setup items can only be assigned and changed from an HAI console. These items can not be assigned or changed via PC Access; although the IP address and port number may be viewed via PC Access - **See Set Up Miscellaneous.**

OmniPro II Ethernet Connections

Use a standard network cable to connect the controller to a hub, switch, or router. Use a network crossover cable when connecting the controller directly to the NIC card on a computer.

When connected to a switch or router, port forwarding must be configured. Port forwarding sets up public services on your network. The OmniPro II controller listens for all IP/UDP communications addressed to it on the specified UDP port number. The router will forward all communications on the specified port to the OmniPro II controller.

Connecting to Network via PC Access

To access the controller over the network via PC Access:

1. Open an OmniPro II account file.
2. Click *Configure >> Network*.
 - If you are connecting from the local network, enter the controller’s IP address under “Network IP Address or Domain Name”.
 - If you are connecting from the Internet, enter either the public IP address (the way to reach your local network via the Internet) or domain name (e.g. www.homeauto.com).
3. Enter the port number that is configured for the controller.
4. Select the *Encryption* tab. Enter the two part encryption key as it is displayed on the console.
5. Select *OK*.
6. Click *Connect >> Network >> Connect*. PC Access should change from “*Off-Line*” to “*On-Line*”.

The “Modem” item on the main menu has been replaced with the “Connect” item. The submenu under “Connect” then allows selection of “Modem”, “Serial” or “Network”. When an account file is opened, the connection type will default to “Serial”.

To connect to an OmniPro II controller on a local network using HAI PC Access, under *Configure >> Network* enter the controller's IP address:

(i.e. 192.168.0.101)

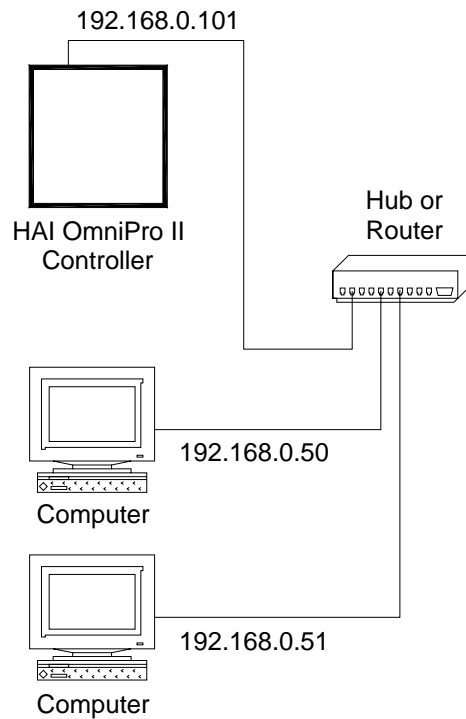

Local Network

Dynamic DNS

If the controller is connected to the Internet via a dynamic IP address, to locate and communicate with the controller from remote locations over the Internet using HAI PC Access, you must subscribe to a Dynamic DNS (Domain Name Service). Dynamic DNS is a service that maps your dynamic (changing) IP address to a static (permanent) hostname, allowing you to access your OmniPro II controller over the Internet using your static hostname instead of an IP address.

A “client” program (typically provided by the Dynamic DNS provider) runs on a PC on your local network and is used to automatically update your Dynamic DNS provider with your current IP address. Several router/switch manufacturers have embedded a Dynamic DNS client into their router firmware. These devices work with several of the Dynamic DNS providers, including both free and commercial services. These devices are especially beneficial because the router can be powered up all the time, so the dynamic update is always current and is handled by a single device (the router/switch) in the local network. This allows you to locate and connect to the OmniPro II controller without having a computer on the local network powered up and running.

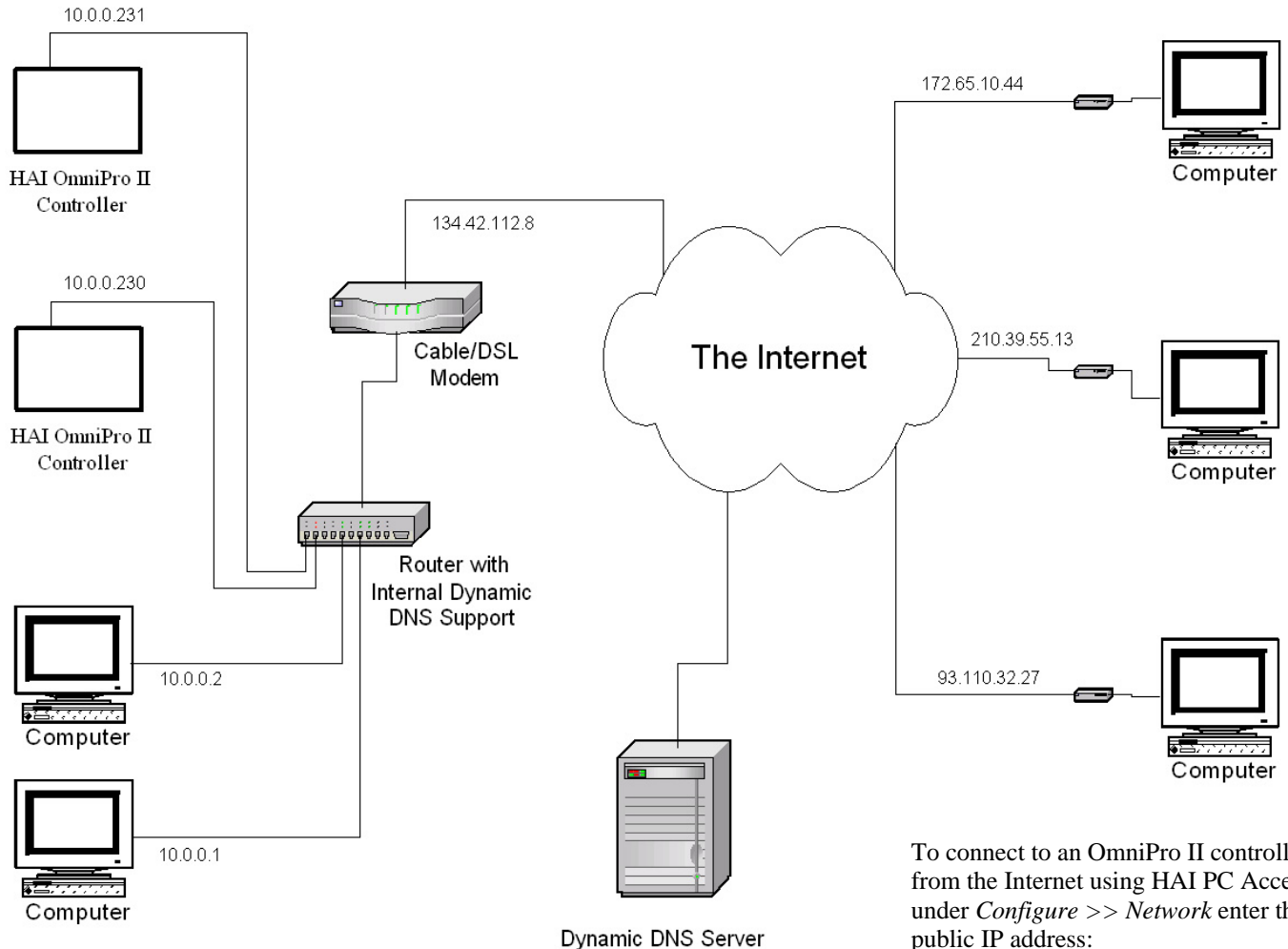

To connect to an OmniPro II controller on a local network using HAI PC Access, under *Configure >> Network* enter the controller's IP address:

(i.e. 10.0.0.230)

To connect to an OmniPro II controller from the Internet using HAI PC Access, under *Configure >> Network* enter the public IP address:

(i.e. 134.42.112.8)

Local / Wide Area Network

SETUP

Configuration and Advanced Control Programming (ACP)

The Setup menu is used to configure operating parameters, program your system to do its automated control and security functions using ACP, and give text and voice descriptions to all of your zones, units, buttons, codes, temperatures, and messages. To enter the Setup menu, from the top-level display or from the main menu, press the 8 (SETUP) key on the console keypad.

Upon entry to the Setup mode, you will first be prompted to enter a security code:

```
SET UP
ENTER CODE :
```

A Master Code is required to enter the Setup mode.

```
SET UP
1=CODES 2=TIME 3=PROG ↓
4=DIAL 5=ARM 6=MISC
7=NAMES 8=VOICE ↑
```

Set Up Codes

OmniPro II has 99 user codes that you may assign to users of the system. All OmniPro II security codes are 4 digits in length (0001 to 9999). Each user should be assigned a security code with an authority level, areas that can be accessed (if area arming is being used), and times in which the code will be valid. To set up a code, from the Setup menu, press the 1 (CODES) key. Use the arrow keys to scroll through the codes.

User Code 1 is always set to a Master code. The existing code number is not shown on the display. To change the code, enter a four digit number, then press the '#' key.

Remember the code number. It will not be redisplayed.

```
CODE 2 :
0000-9999 0000=DISABLE
```

Authority Level

Press the (↓) key. You will then be prompted for an authority level for that code:

```
CODE 2 AUTHORITY: 3
1=MSTR 2=MGR 3=USER ↓
```

1 = Master

Master codes have complete access to the entire system.

2 = Manager

Manager codes can arm and disarm areas that they have access to, during assigned times. Managers can access the Main Menu if the system is in High Security Mode, and have telephone access privilege.

3 = User

User codes can only arm and disarm the system in assigned areas, during assigned times. Telephone access is not a privilege.

Access Areas

After an authority level has been entered, you will be prompted for access areas for the user. Specify which area(s) (if part of your system) the user has access to by pressing the number for each area.

The display will show all areas that have been enabled for that user. After the area(s) is/are selected, press the '#' key.

```
CODE 2 AREAS :  
1 2          0=CLR ↓
```

You can specify the access (on/off) times for the code; this is, the time periods during which the code is valid.

```
CODE 2 ON TIME :  
8:00 AM MTWTF-- #=CHNG↑
```

```
CODE 2 OFF TIME  
5:00 PM MTWTF-- #=CHNG↑
```

The times and days are changed by pressing the '#' key. Choose the 1 (TIME) key to change the On or Off times. You will be prompted to enter the new time. AM/PM must be specified for the time if the AM/PM format is being used, otherwise the entered time should be 13:00-23:59. Each item defaults to its current value. Press the up arrow key to select Sunrise and press the down arrow key to select Sunset.

```
CODE 2 (ON/OFF) TIME :  
1=TIME 2=DAYS  
  
TIME: 8:00 AM  
HHMM ↑=RISE/AM ↓=SET/PM
```

To change days, press the '#' key, then press the 2 (DAYS) key. You will be prompted to enter the day(s) that the code will be valid. Press 1-7 for Monday - Sunday, 0 for Never, 8 for Weekdays, and 9 for Weekends.

```
DAY(S) : MTWTFSS  
1-7=MON-SUN 0=NEVER
```

Duress Code

If you are forced to disarm the system against your will by an intruder, disarm it as you normally would, but use the Duress Code instead of your normal code. The system will disarm normally. No sirens will sound, no lights will flash, but the OmniPro II will perform a silent dial out and say that this is a silent alarm.

To stop a silent dial out, turn your security system off by pressing OFF, then your code.

```
DURESS CODE :  
0000-9999 0000=DISABLE↑
```

Set Up Time

To set up time and date, from the Setup menu, press the 2 (TIME) key. You will be prompted to enter the new time and date. AM/PM must be specified for the time if that format is being used, otherwise the entered time should be 13:00-23:59.

```
TIME :  
HHMM ↑=AM ↓=PM  
  
DAYLIGHT SAVINGS TIME?  
0=NO 1=YES
```

If Daylight Savings Time is currently being observed (between spring and fall), set this item to "Yes". If Daylight Savings Time is not currently being observed (between fall and spring) or is not observed in your geographic location, set this item to "No". This item is used to correctly calculate the times for sunrise and sunset.

You are only asked this question when you set the time. Once the time is set, OmniPro II will automatically adjust the "time of day" each time daylight savings time begins and ends.

```
ENTER DATE :  
MMDDYY
```

Advanced Control Programming (ACP)

Your OmniPro II can be programmed to do automated control and security functions on a time schedule or in response to an event occurring in the system. You may program the following items:

- Unit Numbers: On, Off, On for time, Off for time, Dim, Brighten, Dim for time, Brighten for time, Level, and Scene
- Settings for HAI Communicating Thermostats
- PESH control: On, Off, On for time, Off for time, and Heat and Cool setback temperatures
- Temperatures: Low and High temperatures
- All lights On, All Off
- Security modes Off, Day, Night, Away, Vacation, Day(Instant), and Night(Delay) and bypass and restore zones
- Buttons (Events)
- Messages: Show, Log, Clear, Say, Phone, and Send

The OmniPro II executes programs:

- Once at a certain time on a certain date (One-Time Program)
- On a certain date every year (Yearly Program)
- Repeatedly (Repeating Programs)
- In response to an event (Button Programs)

You can also specify 2 conditions in each program, so that they only run under certain circumstances.

Every line of programming in the OmniPro II controller consists of three pieces. Each line **must** have at least an event (when) and a result (command). The "&IF" statement (condition) is optional in all programming lines.

The program may specify up to 2 conditions that must be true for the program to execute. When programming from the console, only 1 condition can be selected. If 2 conditions must be specified for a single program line, it must be entered using the PC Access Software.

Each program can be set up to execute at a certain time of day or on the occurrence of a particular event in the system. When this time or event occurs, the programmed action will be taken if, and only if, the specified condition(s) is also true at that time.

The Program menu allows you to add, review, change, and delete automation programs. To enter the Program menu, from the Setup menu, press the 3 (PROG) key.

```
SET UP PROGRAMS
1=ADD    2=SHOW  3=DELETE
```

1 = Add Programs

The 1 (ADD) key is used to add new automation programs to the system. When you press the 1 (ADD) key, the *Edit Program* menu is displayed which allows the various parts of a program to be specified - **See Edit Program**. You may edit each part of the program as specified under *Edit Program*. Press the '#' key at the *Edit Program* menu to show the newly entered program. Press the '#' key again to save the program, or press the '*' key to return to the *Edit Program* menu to cancel entry of the new program and return to the Set Up Programs menu.

Once the new program is entered, the display will return to the Set Up Programs menu.

2 = Show Programs

The 2 (SHOW) key is used to review, edit, and delete existing programs. From the Set Up Program menu, press the 2 (SHOW) key. The display prompts you to specify which program to be reviewed.

```
1=CTRL  2=SEC   3=BTTN
4=ALL   5=TEMP  #=EVERY
```

- Menu 1 - Programs for a particular control unit number
- Menu 2 - All Security related programs
- Menu 3 - Programs for a particular macro button
- Menu 4 - Programs for All On/Off functions
- Menu 5 - Programs for a particular Temperature zone
- Menu # - Displays every program

Selecting the 1 (CTRL) or 5 (TEMP) key will prompt you to specify the desired unit or temperature zone. These can be specified by entering the number, followed by the '#' key or by using the arrow keys to scroll through a list of items.

```

UNIT:
ENTER UNIT          ↓

TEMPERATURE ZONE
ENTER TEMPERATURE ZONE ↓

```

Selecting the 3 (BTTN) key will prompt you to specify the desired button number. These can be specified by entering the number, followed by the '#' key or by using the arrow keys to scroll through a list of items.

```

BUTTON:
ENTER BUTTON      #=MENU ↓

```

Pressing the '#' key first will bring up a menu of event button types to select from:

```

BUTTON TYPE
1=CTRL  2=SEC  3=ZONE ↓

4=ALL   5=ALARM 6=X-10
7=MISC                                     ↑

```

If there are no programs for the specified item, the console will beep three times and will display:

```

*** NO PROGRAMS ***

```

Otherwise, a help screen is displayed:

```

Press # to delete or
edit displayed program.↓

```

The first program is displayed once the down arrow is pressed. The top line displays the time or button/event that activates the program and any condition that must be true for the program to activate. The bottom line shows the command to execute when the program is activated.

```

10:00 PM MTWTFSS  &AWAY
Living Rm Lt ON

6:00 AM 10/10     &NIGHT
PROGRAM DAY

WHEN AWAY:
ALL OFF

```

When 2 conditions are part of a single program, the conditions are not displayed on the console. Instead, "&MULTI" is displayed to let you know that this program line contains 2 conditions. To view or edit the program, you must use the PC Access Software.

```

WHEN ZONE 1 NR:  &MULTI
FOYER LIGHT ON

```

The arrow keys are used to scroll through the programs. Pressing the '#' key while a particular program is displayed will allow that program to be edited or deleted. The display shows:

```
SHOW PROGRAM
1=EDIT  2=DELETE
```

- Press the **1 (EDIT)** key to edit the selected program. The *Edit Program* menu is displayed which allows the various parts of the program to be changed - **See Edit Program**. Edit each part of the program as specified under *Edit Program*. Press the '#' key at the *Edit Program* menu to show the newly edited program. Press the '#' key again to save the program, or press the '*' key to cancel edit of this program and return to reviewing the programs.
- Press the **2 (DELETE)** key to delete the selected program.

3 = Delete All Programs

To delete All automation programs, from the Set Up Program menu, press the 3 (DELETE) key. The display will prompt you to confirm the deletion.

```
DELETE ALL PROGRAMS?
0=NO  1=YES
```

Select 1 (YES) to delete all automation control programs in the system. Select 0 (NO) or press the '*' key to return to the Set Up Program menu.

NOTE: IF YOU CHOOSE THIS OPTION, ALL OF YOUR PROGRAMS WILL BE LOST PERMANENTLY.

Edit Programs

The *Edit Program* menu is used to specify each part of an automation program.

```
EDIT PROGRAM
1=WHEN  2=CMD  3=&COND
```

- Selecting **1 (WHEN)** allows the time or event that activated the program to be specified.
- Selecting **2 (CMD)** allows you to specify the action to be taken when the program is executed.
- Selecting **3 (&COND)** allows a condition to be specified that must be true for the program to be executed at the specified time.

Each of these items defaults to its current setting for an existing program that is being edited, or to a default value for a new program.

For each program, it is only necessary to specify the time or event and the action to be taken. It is not necessary to specify a condition on the program if the action should be taken whenever the specified time or event occurs.

Edit Programs When

Selecting the 1 (WHEN) key, from the *Edit Program* menu, allows the time or button/event that activates the program to be changed. The display shows:

```
EDIT WHEN
1=TIMED 2=BUTTON
```

Times Programs

Selecting 1 (TIMED) sets the program to be activated at a specific time of day. You are prompted to enter the time and date or days of week. The current default value is shown for each item. Press '#' to accept the default.

```
12:00 AM 5/17
1=TIME 2=DATE/DAY
```

Select 1 (TIME) to enter the new time. If the desired time is the time in which sunrise or sunset will occur, press the up arrow key for sunrise, or the down arrow key for sunset before entering a time.

```
TIME: 12:00 AM
HHMM ↑=RISE/AM ↓=SET/PM
```

You may also choose to have the program execute up to 120 minutes before or after the time of sunrise or sunset.

```
SUNSET
1=BEFORE 2=AFTER #=AT
```

If the 1(BEFORE) or 2(AFTER) key is selected, you will be prompted to select the amount of minutes:

```
ENTER OFFSET:
0-120 MINUTES
```

When entering a time of day, AM/PM must be specified for the time if the AM/PM format is being used. Otherwise the entered time should be 13:00-23:59.

```
TIME: 8:00 AM
HHMM ↑=RISE/AM ↓=SET/PM
```

Select 2 (DATE/DAY) to enter a new date or days of week.

```
DATE: 10/15
MMDD ↓=DAY
```

Next, specify if the program will run once (on the specified date and then be deleted) or if the program will run every year on the specified date (yearly).

```
RUN PROGRAM
1=ONCE 2=YEARLY
```

To change days, press the down arrow (DAY) key. You will be prompted to enter the day(s) that the program will be activated. Press 1-7 for Monday - Sunday, 0 for Once, 8 for Weekdays, and 9 for Weekends, then '#'.

```
DAY(S) : M-W-F--
1-7=MON-SUN 0=ONCE
```

Press the '#' key and the display will then return to the *Edit Program* menu:

```
EDIT PROGRAM
1=WHEN 2=CMD 3=&COND
```

Button and Event Programs

Selecting 2 (BUTTON), from the "Edit When" menu, sets up a program to be activated when a macro button is executed or an event occurs. The user is prompted to specify the button/event that activates the program:

```
BUTTON :  
ENTER BUTTON    #=MENU ↓
```

A specific macro button may be activated by entering the button number followed by the '#' key, or by using the arrow keys to scroll through a list of buttons.

To program specific event buttons (i.e. Front Door Opens, Security Armed Away, Porch Light Turns On, etc.), press the '#' key to bring up a menu of event button types:

```
BUTTON TYPE  
1=CTRL  2=SEC  3=ZONE ↓  
  
4=ALL   5=ALARM 6=X-10  
7=MISC  8=MSG  9=SWITCH ↑
```

After the event button is specified, the display returns to the *Edit Program* menu.

Control Unit / Switch Press Event Buttons

This Event Button is activated upon the following:

- When the specified Unit is turned on or off
- When the top-rocker or bottom-rocker is pressed on a UPB, RadioRA, or ALC switch
- When a button is pressed on a UPB 6-Button or 8-Button Keypad
- When a button is pressed on a RadioRA Master Control
- When a button is pressed on a ALC 4-Button Scene Switch Module

Press the 1 (CTRL) key to select the "When Command" for a control unit event.

```
UNIT :  
ENTER UNIT    ↓
```

The unit may be selected by entering the unit number followed by the '#' key or by using the arrow keys to scroll through a list of unit names. Select the desired unit. Next, you are prompted to specify the event that activates the program:

```
WHEN Porch Light :  
0=OFF 1=ON  2=SWITCH
```

Press the 0 (OFF) key to select when the unit turns off or press the 1 (ON) key to select when the unit turns on (this program is executed whenever the unit is turned off or on).

Press the 2 (SWITCH) key to select only when the top-rocker or bottom-rocker is pressed at a UPB, RadioRA, or ALC Switch (locally at the Switch) or when a button is pressed on a keypad.

```
SWITCH :  
0=OFF 1=ON 2-11=SW1-SW10
```

Press "0" to select only when the bottom-rocker (off) is pressed on the Switch. Press "1" to select only when the top-rocker (on) is pressed on the Switch. Press "2-9" (see the Corresponding Switch Table) to select when that button is pressed on a keypad.

Press the '#' key to enter your selection.

Corresponding Switch Table

Switch	OmniPro II	UPB 6-Button Keypad	UPB 8-Button Keypad	RadioRA Master Control	ALC 4-Button
1	2	On Button	1 or E	1	1
2	3	Off Button	2 or F	2	2
3	4	A	3 or G	3	3
4	5	B	4 or H	4	4
5	6	C	5 or I	5	
6	7	D	6 or J	6	
7	8		7 or K	7	
8	9		8 or L	8	
9	10			9	
10	11			10	

Security Mode Event Buttons

Pressing the 2 (SEC) key allows you to select the event button that will be activated when a security mode changes:

```
0=OFF    1=DAY    2=NIGHT
3=AWAY   4=VACATION  ↓
```

After the security mode is selected, an additional menu appears which allows you to further specify the event button. For example, you would like to activate an event button when you arm the system into the 3 (AWAY) mode:

```
WHEN AWAY :
1=DELAY 2=CODE 3=AREA
```

Any of these may be selected alone or in combination. As each item is specified, the menu is redisplayed with the updated event button description. Press the '#' key when done.

- Selecting 1 (DLY) allows the user to specify whether the event button is activated at the start or end of the exit delay:

```
WHEN ACTIVATED?
1=START EXIT 2=END EXIT
```

When you specify that the event button is activated at the start of the delay by pressing the 1 (START EXIT) key, the mode is prefixed by "A-" for "arming into".

```
WHEN AWAY :                (END OF DELAY)
WHEN A-AWY :                (START OF DELAY)
```

When the system is armed in the Day (instant) or Night (delay) mode, event buttons for the Day and Night modes are executed, respectively.

- Selecting 2 (CODE) allows you to specify that the event button is activated only when a particular code is used. You will be prompted to enter the code:

```
ENTER USER CODE :
1-16                0=ALL ↓
```

You should enter the user code by entering the code number followed by the '#' key or by using the arrow keys to scroll through a list of code names.

```
WHEN C1 AWAY :
1=DELAY 2=CODE 3=AREA
```

- Selecting 3 (AREA) allows you to specify that the event button is activated only when the specified area is armed or disarmed. You will be prompted to enter the area:

AREA :
ENTER AREA 0=ALL ↓

The area number should be entered followed by the '#' key, or the arrow keys may be used to scroll through a list of areas.

WHEN C1 A1 AWAY :
1=DELAY 2=CODE 3=AREA

Zone Event Buttons

Pressing the 3 (ZONE) key allows you to select the event button for a zone activation event. You are first prompted to enter the desired zone number:

ZONE :
ENTER ZONE ↓

The zone number should be entered followed by the '#' key, or the arrow keys may be used to scroll through a list of zones. The desired zone is then displayed and you are prompted to specify the state that activates the event button:

WHEN Front Door :
0=SECURE 1=NOT RDY

All On/Off Event Buttons

Pressing the 4 (ALL) key allows you to specify an event button activated by issuing an All On or an All Off command, issuing a Leviton Scene command, or issuing a UPB Link command. You are first prompted to specify whether the event button is for All Lights On, All Off, Leviton Scene, or UPB Link:

ALL
0=OFF 1=ON 2=SCN 3=LINK↓

If area arming is being used, you will be prompted to specify the desired area:

AREA :
ENTER AREA 0=ALL ↓

If Leviton Scene is selected, you must first specify the scene number:

ENTER SCENE :
1-256

Then select the specified command Off, On, or Set.

If UPB Link is selected, you must first specify the link number:

ENTER LINK :
1-250

Then select the specified command Off, On, or Set.

UPB Link Event Buttons

When a program is created that uses "When Link On" as the trigger, the program will execute when a "Link Activate", "Link Goto" (as long as the result of the Goto command is not "0"), or "Link Fade Start" (as long as the result to the Fade command is not "0") message is received.

When a program is created that uses "When Link Off" as the trigger, the program will execute when a "Link Deactivate" or "Link Goto" (where the result of the Goto command is "0") message is received.

Using HAI PC Access Software, you can create a program that uses "When Link Fade Stop" as the trigger. When this trigger is used, the program will execute when the "Link Fade Stop" message is received.

Alarm Event Buttons

Pressing the 5 (ALARM) key allows you to specify an event button activated upon the occurrence of an alarm. You are first prompted to select the type of alarm:

```
SELECT ALARM TYPE
ANY TYPE          ↓
```

The arrow keys are used to select from a list of alarm types:

- ANY ALARM
- BURGLARY ALARM
- FIRE ALARM
- GAS ALARM
- AUXILIARY ALARM
- FREEZE ALARM
- WATER ALARM
- DURESS ALARM
- TEMPERATURE ALARM

Press the '#' key when the desired alarm type is shown. You are then prompted to specify the area, if area arming is being used:

```
AREA :
ENTER AREA      0=ALL ↓
```

The area number should be entered followed by the '#' key, or the arrow keys may be used to scroll through a list of areas.

X-10 Event Buttons

Pressing the 6 (X-10) key allows you to specify an event button activation upon receipt of an X-10 command from a source external to OmniPro II. The OmniPro II can also respond to scene changes initiated at Compose keypads and dimmers. When a scene change is initiated, OmniPro II can activate an event button program. You are first prompted to enter the X-10 house code:

```
X-10 HOUSE CODE :
1-16=A-P
```

You are then prompted to enter the X-10 unit code:

```
X-10 UNIT CODE :
1-16              0=ALL
```

Finally, you are prompted to specify the command that activates the event button:

```
WHEN X-10 A1 :
0=OFF 1=ON 2=SCENE
```

After specifying the X-10 House Code and X-10 Unit Code, select 0 for Off, 1 for On, or 2 for Scene.

"Off" events will be activated whenever the selected device is turned off. "On" events will be activated whenever the selected device is turned on. "Scene" events will be activated whenever the selected device is set to the specified scene. "On" events will also be activated whenever the selected device is set to a scene other than off.

Miscellaneous Event Buttons

Pressing the 7 (MISC) key allows you to select an event button from a list of other event buttons. You are first prompted to select the event button:

```
SELECT BUTTON :
WHEN PHONE DEAD ↓
```

The arrow keys are used to select from a list of event buttons:

- WHEN ENERGY LO
- WHEN ENERGY MID
- WHEN ENERGY HI
- WHEN ENERGY CRIT
- WHEN PHONE DEAD
- WHEN PHONE RING
- WHEN PHONE OFFHK
- WHEN PHONE ONHOOK
- WHEN AC PWR OFF
- WHEN AC PWR ON
- WHEN BATTERY LOW
- WHEN BATTERY OK
- WHEN DCM FAIL
- WHEN DCM OK
- WHEN CAMERA* (PA Access only)

*When a camera input (1-6) is pressed on an OmniTouch with Video. This item can only be programmed via PC Access.

Message Event Buttons (Pro-Link)

Pressing the 8 (MSG) key allows you to select an event button from a list of the 64 text messages. You are first prompted to select the message:

```
MESSAGE :  
ENTER MESSAGE      ↓
```

The message may be entered by entering the message number followed by the ' #' key or by using the arrow keys to scroll through the list of messages.

Pro-Link also has the capability to monitor the serial port for incoming text messages. When a text message is received, Pro-Link searches through all 128 text messages for a matching message. If one is found, the *When Message Received* event button corresponding to the matching message is activated.

Pro-Link determines that a message has been received when:

- One or more characters have been received followed by 100 ms of silence
- One or more characters followed by a carriage return character are received
- One or more characters followed by a line feed character are received

It is not necessary to enter the terminating carriage return or line feed character as part of the message name.

Switch Press Event Buttons (Centralite)

When a button is pressed on a Centralite keypad, the "When Switch" program is activated.

Pressing the 9 (SWITCH) key allows you to select the "When Command" for a switch pressed activated event.

You are first prompted to enter the switch number:

```
SWITCH NUMBER :  
1-127          ↓
```

Enter the switch number followed by the ' #' key.

Edit Program Command

Selecting 2 (CMD), from the *Edit Program* menu, allows the commanded action for the program to be specified. The following menu is displayed:

```
1=CONTROL    2=SECURITY
3=BUTTON     4=ALL      ↓
5=TEMP       6=ENERGY
8=MESSAGE    ↑
```

After the command is specified, the display returns to the *Edit Program* menu:

Program Control Commands

Press the 1 (CONTROL) key to command lights and appliances. Specify the desired command - See *Control*.

```
Porch Light (Unit Name)
0=OFF 1=ON 2=DIM 3=BRT ↓
```

```
Porch Light (Unit Name)
4=LVL 5=RMP 9=TIM #=STA↑
```

If the selected unit is part of a House Code that is configured to use the Compose Format, the second page of the menu is modified to allow Scene commands. Consequentially, the Level and Ramp Commands are removed from the menu.

```
Entry Lights (Unit Name)
4=SCN 9=TIM      #=STA↑
```

If the selected unit is not capable of dim and bright commands, only a single menu is shown.

```
Porch Light (Unit Name)
0=OFF 1=ON 9=TIM #=STA
```

If the selected unit is UPB, press 6 (LED) to control an LED on a UPB Keypad.

On the 6-Button Keypad: LED 1 is behind the “On” button, LED 2 is behind the “Off” button, and LED 3-6 is behind the A-D buttons, respectively. On the 8-button Keypad: LED 1-8 is behind the 1-8 buttons, respectively. For example:

```
WHEN U1 SW 3:
UNIT 1 LED 3 ON
```

This program illuminates the “A” button (on a 6-Button Keypad) when the “A” button on that keypad controller is pressed. This program can also be used to illuminate the “3” button (on an 8-Button Keypad) when the “3” button is pressed.

If the selected unit is UPB, the # (STA) key is used to request the status form the specified UPB device.

```
WHEN LINK 1 ON:
Porch Light STATUS
```

When “Link 1 On” is received on the UPB network, OmniPro II sends a status request message to the UPB Wall Switch (named Porch Light) to acquire its current status.

This “Status Request” program is particularly beneficial to keep the current state of UPB devices that are altered by a “lighting scene” (Link On or Link Off) command. When the Link On or Link Off command is transmitted by a 6-Button or 8-Button Keypad Controller, each device that has that Link pre-configured will respond to its preset levels. At this point, OmniPro II no longer knows the exact state of the units that responded to the specified Link command until the switch is pressed locally, the controller sends a command message to the device, or a Status Request message is issued to the device.

Unit Toggle Command

Using HAI PC Access Software, you can create programs to toggle any unit (1-511) from its current state to the opposite state.

When the program is executed, the unit will toggle to Off if the unit is currently in a non-off state (On, On for time, Level 1-100, Scene A-L, Dimmed Steps, Dimmed for time, Brightened Steps, or Brightened for time).

When the program is executed, the unit will toggle to On if the unit is currently Off.

Note: If a unit is currently timed (On for time, Dimmed for time, Brightened for time, or Off for time), when the toggle program is executed, the unit will toggle to the opposite state and will defeat the timer.

This programming feature will simplify programming when using a button on a UPB, Compose, ALC, or RadioRA keypad to toggle a light on and off with the push of a single button. For example:

```
WHEN FRONT FOYER SW1 PRESSED: FRONT FOYER TOGGLE
```

Program Security Commands

Press the 2 (SECURITY) key to arm and disarm the security system, or to bypass and restore an individual zone. The following menu is displayed:

```
0=OFF    1=DAY    2=NIGHT
3=AWAY   4=VACATION  ↓
5=DAY INST 6=NIGHT DLY
8=BYPASS  9=RESTORE  ↑
```

Select (0-6) to arm the system into the desired mode or select the 8 key to Bypass and the 9 key to Restore a security zone. If area arming is being used, the display will then prompt you for the area to be armed:

```
AREA
ENTER AREA    0=ALL ↓
```

Enter the area number followed by the '#' key, or use the arrow keys to scroll through a list of areas. Press the '#' key first to specify all areas.

Program Button Commands

Select the 3 (BUTTON) key to program a macro button. Specify the macro button to be executed - *See Button Programs*.

```
BUTTON:
ENTER BUTTON  # =MENU ↓
```

Program All On / All Off Commands

Select the 4 (ALL) key to program All Lights On and All Units Off commands. It is also used to program Leviton Scenes, UPB Link, RadioRA Phantom Button, or Centralite Scene.

```
ALL
0=OFF 1=ON 2=SCN 3=LINK ↓
ALL
4=PHANTOM 5=CENLIT ↑
```

If area arming is being used, the display will then prompt you for the area to control. Enter the area number followed by the '#' key, or use the arrow keys to scroll through a list of areas. Press the '#' key first to specify all areas.

Program Video Commands*

This program command is used to display video automatically on an OmniTouch with Video touchscreen when an event occurs.

You can specify which camera and which touchscreen(s) will display the video when the event takes place. When the event takes place, it switches each of the specified touchscreens to full screen video.

* This item can only be programmed via PC Access.

Program Temperature Commands

Select the 5 (TEMP) key to control HAI Communicating Thermostats, energy saver modules, and temperature sensors. Specify the desired command - **See Temperature**.

```
TEMPERATURE :  
ENTER TEMP ZONE  0=ALL ↓
```

Program Energy Cost

Select the 6 (ENERGY) key to command the energy cost rate. Specify the desired energy cost rate:

```
ENERGY COST :  
0=LO 1=MID 2=HI 3=CRIT
```

Program Message Commands

Select the 8 (MESSAGE) key to show, log, clear, say, phone, or send a message. Specify the desired command - **See Message**.

```
MESSAGE  
1=SHOW 2=LOG 3=CLEAR↓  
4=SAY 5=PHONE 6=SEND  
↑
```

The 1 (SHOW) key allows you to display the selected text message(s) on the console's top-level display. This can be a helpful reminder of special events and occasions.

The 2 (LOG) key allows you to store the selected text message(s) in the Event Log. This can be a helpful to keep track of the times and dates of events and occurrences.

The 3 (CLEAR) key allows you to clear the selected text message, or all text messages from the console's display.

The 4 (SAY) key allows the controller to say the selected voice message over a speaker. This voice message can be an audible reminder of special events and occasions (i.e. "Front Door Open" when the front door is opened).

The 5 (PHONE) key allows the controller to call the selected phone number and say the selected voice message.

The 6 (SEND) key allows you to send any a text messages through the Pro-Link serial port.

Edit Program Condition

Selecting the 3 (&COND) key, from the *Edit Program* menu, allows the condition for the program to be specified. The condition is optional in all program lines. This condition must be true when the program time or event occurs for the program to be executed.

Note: Two (2) conditions can be specified in each program line; however, when programming from the console, only 1 condition can be selected. If 2 conditions must be specified for a single program line, it must be entered using the PC Access Software. When 2 conditions are part of a single program, the conditions are not displayed on the console. Instead, "&MULTI" is displayed to let you know that this program line contains 2 conditions. To view or edit the program, you must use the PC Access Software.

The following menu is displayed:

```
SELECT CONDITION
1=CTRL  2=SEC  3=ZONE ↓
          9=TIME      #=MISC
                                     ↑
```

After the condition is specified, the display returns to the *Edit Program* menu.

Program Control Conditions

Press the 1 (CTRL) key to specify that the program should only execute if a specified control unit is either On or Off.

The display prompts for the unit number:

```
UNIT :
ENTER UNIT ↓
```

Enter the unit number followed by the '#' key, or use the arrow keys to select the unit.

The unit is displayed and the display prompts for the state of the unit:

```
IF Porch Light :
0=OFF 1=ON
```

Program Security Mode Conditions

Press the 2 (SEC) key to specify that the program should only execute if the security system is armed in a particular mode. Select the security mode from the following menu:

```
0=OFF 1=DAY 2=NIT 3=AWY
4=VAC 5=DYI 6=NTD
```

Next, select whether the system is considered in the specified mode during the exit delay:

```
INCLUDE EXIT DELAY?
0=NO 1=YES
```

If area arming is being used, the display will then prompt you to specify the area.

Program Zone Conditions

Select the 3 (ZONE) key to specify that the program should only execute if a specified security zone is either **Secure** or **Not Ready**. The display prompts you for the zone number:

```
ZONE :
ENTER ZONE ↓
```

Enter the zone number followed by the '#' key, or use the arrow keys to select the zone.

The zone will be displayed and you will be prompted for the state of the zone:

```
IF Front Door:
0=SECURE    1=NOT RDY
```

Program Time Clock Conditions

Select the 9 (TIME) key to specify that the program should only execute if a specified Time Clock is either On or Off. The display prompts you for the Time Clock number:

```
ENTER TIME CLOCK:
1-3
```

Enter the Time Clock number followed by the '#' key.

Next, specify the state of the time clock:

```
IF TIME CLOCK 1:
0=OFF 1=ON
```

Program Other Conditions

Select the # (OTHER) key to select a condition from a list of other conditions.

```
SELECT CONDITION:
NONE                ↓
```

Choose "NONE" when editing a program and choose not to conditionalize the program.

```
SELECT CONDITION:
NEVER              ↑
```

Choose "NEVER" if you wish to temporarily deactivate a program without deleting it.

Other conditions include:

- IF LIGHT
- IF DARK
- IF ENERGY LO
- IF ENERGY MID
- IF ENERGY HI
- IF ENERGY CRIT
- IF PHONE DEAD
- IF PHONE RING
- IF PHONE OFFHK
- IF PHONE ONHOOK
- IF AC PWR OFF
- IF AC PWR ON
- IF BATTERY LOW
- IF BATTERY OK

Set Up Dial

The *Set Up Dial* menu is used to configure all of the telephone related items for the OmniPro II. To enter the *Set Up Dial* menu, from the Setup menu, press the 4 (DIAL) key. Use the arrows to scroll through the items. For each item, the top line displays a description of the item and its current setting. The bottom line shows the available ranges for your selections.

Phone numbers can be up to 24 characters long. The number is shown on the bottom line of the display. Press the OFF key to enter a ' - ' into the number. Press the DAY key to specify a pause of 2 seconds (shown as a "T" on the display). Press the NIGHT key to enter a ' # ' into the number. Enter a single ' - ' for no number.

Telephone Access

The *Telephone Access* item allows you to turn the local (in-house) and remote telephone control feature on and off.

If set to On, the OmniPro II will allow local and remote telephone access as described in Telephone Control. If set to Off, the OmniPro II will not answer incoming calls ever, and will not work on the in house phones. Dial outs will still occur, and the system will operate normally when the OmniPro II dials out.

If you do not have your OmniPro II connected to a phone line, set *Telephone Access* to Off to keep the system from displaying "PHONE LINE DEAD". The default setting for *Telephone Access* is On.

Answer Outside Call

If you do not want your system to *Answer Outside Call*, set this item to No. The local (in-house) telephone control features will still work, but the system will never answer an incoming call.

The default setting for *Answer Outside Call* is Yes.

Remote Commands

The *Remote Commands Ok* item allows you to prevent any commands from being issued from a remote telephone.

If *Remote Commands Ok* is set to Yes, the OmniPro II will allow all commands to be executed when called from a remote telephone. If *Remote Commands Ok* is set to No, then lights, appliances, and the security system cannot be controlled from a remote telephone that dials into your home.

You can issue commands from a local (in-house) phone with *Remote Commands Ok* set to Yes or No. The default setting is Yes.

Rings Before Answer

Your phone must ring this number of times before the OmniPro II will answer an incoming call to your phone.

To change *Rings Before Answer*, enter the new number from 1 to 15, then press the ' # ' key. The factory default setting is 8.

Dial Type

The *Dial Type* specifies the type of dialing used when the OmniPro II dials out. If you do not have Touch-Tone service, then *Dial Type* must be set to Pulse.

The default *Dial Type* is Tone.

My Phone Number

My Phone Number is the phone number that will be announced when the OmniPro II dials out in the event of an alarm. It should be set to the phone number of the premises where your system is installed.

To enter phone numbers, press the keypad keys 0 - 9. You can put in a dash (-) for legibility by pressing the Off key.

Press the ' # ' key after you have pressed all of the digits in the phone number. For example, to enter the number 555-1234, press 555 "OFF" 1234 #.

Dial Out Number 1

Dial Out Number 1 is one of the 8 numbers that are stored in the system. In the event of an alarm, these numbers are dialed in the order that is set up in the *Dial Out Order* for the particular type of alarm.

Dial out numbers 1 - 8 have On and Off times and days, so that no time is wasted calling you at the office at night or on a Sunday if the alarm is activated.

For dial out number 1, you should enter your office number where you can be reached during working hours.

Enter the phone number the same way as described for My Phone Number.

You can cause the system to pause for two seconds between digits of the number by pressing the DAY key, which puts a T in the number. Multiple Ts for longer pauses are allowed. You can also press the NIGHT key (*) and the AWAY key (#) for symbols to get through some types of telephone or pocket beeper/pager systems.

If you wish to remove a phone number for a particular dial out number, press OFF then ' #' (with the display showing a *Dial Out Number*) to enter a single dash (-).

Phone numbers can be up to 24 digits.

DIAL OUT 1 ON
DIAL OUT 1 OFF

Dial Out Number 1 has two times associated with it, an On and Off time. The OmniPro II will only call this number if the time and days are between the Dial Out 1 On and Dial Out 1 Off times and dates.

Press # to change the On and Off times - **See Set Up Codes.**

```
DIAL OUT 1 ON:  
12:00 AM MTWTFSS #=CHNG↑  
  
DIAL OUT 1 OFF:  
NEVER #=CHNG↑
```

For example, if your normal work hours are 8 to 5 Monday through Friday, then set Dial Out 1 On to 8:00 AM MTWTF and Dial Out 1 OFF to 5:00 PM MTWTF. With these settings, the system will call *Dial Out Number 1* only if the alarm is activated on weekdays between the hours of 8:00 AM to 5:00 PM.

The default for *Dial Out 1 On* is 12:00 AM MTWTFSS, and the default for *Dial Out 1 Off* is Never, so that *Dial Out Number 1* is always active.

The Time that was entered before setting an On or Off time to Never is saved, and will be redisplayed when a day is set in place of Never. Setting both the *Dial Out 1 On* and the *Dial Out 1 OFF* times to Never will make Dial Out Number 1 never active.

Dial Out Numbers 2-8

The default Dial Out On and Off times are the same as *Dial Out Number 1*.

Dial Order

The dial order is the order in which call all will be placed if an Alarm is activated.

You can have the system make up to 8 calls in the event of an alarm. You may chose from *Dial Out Numbers 1 - 8*. You can have the system dial a number twice (or more) which is suggested if you don't have a direct dial number at work, so that your company operator can find you, if you aren't at your desk, and have you alerted for the next call.

Up to eight numbers may be entered. Enter the *Dial Out Order* by pressing the keypad digits 1, 2, 3, 4, 5, 6, 7, or 8 for *Dial Out Numbers 1, 2, 3, 4, 5, 6, 7, or 8*, respectively. When you have entered the dial order of your choice, press ' # '. Enter a single ' 0 ' if no dial out is desired. The default *Dial Order* is 1 2 3 4 5 6 7 8.

Set Up Arming

To configure different arming and disarming options, from the Setup menu, press the 5 (ARM) key.

Entry Delay

The *Entry Delay* is the time, in seconds, that you have to turn off the alarm after entering your home. The *Entry Delay* **only** applies to the entry/exit zone (i.e. your doors). If you (or someone else) come in through a window, there will be no entry delay and the alarm will sound immediately.

When you come in through a door on an entry/exit zone, the other zones are delayed too. This allows you to get to your phone or console to turn off the security system, even if you have to go through a room protected by a motion detector.

Some doors (a back door or garage door) may be configured as a *Double or Quadruple Entry Delay*. If so, that door has two times or four times the entry delay shown on the display.

The default *Entry Delay* is 15 seconds. If you wish to allow yourself more time to get in and turn off the security system, you may set the entry delay between 15 and 45 seconds.

```
ENTRY DELAY:          15
15-45 SECONDS        ↓
```

The console will beep and the new entry delay will be displayed.

Exit Delay

The *Exit Delay* is the time, in seconds, that you have to leave your house when you turn on the system. When arming the system in Day, Night, or Away modes, the system will wait this amount of time before arming.

The default exit delay is 15 seconds. You may change it from 15 to 180 seconds.

```
EXIT DELAY:          15
15-180 SECONDS      ↑↓
```

Audible Exit Delay

The *Audible Exit Delay* is an audible indication from the console beeper while the exit delay is in effect. During the last 10 seconds of the exit delay, the audible indication will beep twice as fast to let you know that you must leave at once.

The default setting for *Audible Exit Delay* is Yes.

Entry/Exit Chime

When *Entry/Exit Chime* is set to Yes, the console(s) will beep once when a door on an entry/exit zone is opened, even if the alarm system is off. This lets you know when someone enters and leaves.

The default setting for *Entry/Exit Chime* is Yes.

Perimeter Chime

When *Perimeter Chime* is set to Yes, the console(s) will beep once when a window or any other perimeter zone is opened, even if the alarm system is off.

The default setting for *Perimeter Chime* is Yes.

Enable Quick Arm

The *Quick Arm* feature allows the security system to be armed by pressing the desired mode key twice instead of having to enter your code.

The default setting for *Enable Quick Arm* is No.

Enable Auto Bypass

The *Auto-Bypass* feature allows the system to automatically bypass an open zone when the system is armed, rather than setting off the alarm. In some applications, it may be preferable to allow arming **only** if all zones are secure (READY).

With *Auto-Bypass* Off, all zones to be armed must be secure when the system is armed. Otherwise, the console will beep three times and display "ZONE NOT RDY". If the system is armed and a zone is open when the Exit Delay expires, the alarm will sound.

All On For Alarm

This option will instruct OmniPro II to execute an X-10 All On command in the event that any type of alarm occurs.

Beep On Trouble

If the OmniPro II detects any troubles with itself or one of the zones connected to it, it will display a message on the screen and beep the console twice per second, continuously (i.e. beep beep...beep beep...). You can silence this sound by pressing the ' * ' key. However, if the trouble occurs again, the beeper will start beeping again.

If you do not wish to hear the beeping sound when a trouble occurs, set *Beep On Trouble* to No.

The default setting for *Beep On Trouble* is Yes.

Set up Miscellaneous

To configure Miscellaneous items in the system, from the Set Up menu, press the 6 (MISC) key.

High Security Mode

In *High Security Mode*, the Master or Manager code is always required to do the following functions:

- Any Control functions
- Any Temperature Control
- View the Event Log
- Access the system from a local phone

With *High Security Mode* Off, no code is required to access a local telephone.

If your system is set up with *High Security Mode* On, the display will request the Master or Manager code whenever you select one of these functions, even if the security system is Off. Simply enter your Master or Manager code.

Your system was shipped from the factory with *High Security Mode* Off, which allows you to view the event log and access the local phones without having to enter a code. In most residential applications, this is appropriate. If you have a commercial installation, or would like added protection from unauthorized access to the system, you may wish to turn on *High Security Mode*.

Announce Alarms

If a Two-Way Audio Module is being used in a system, this item enables the system to speak the type of alarm and zone over a speaker on premises. When an alarm first occurs, the siren is activated. After a few seconds, the siren is turned off and the type of alarm is announced. The siren is then reactivated.

The default for *Announce Alarms* is No.

Enable Freeze Alarm

If there are one or more Thermostat or PESM in a system, they can also be used to detect a freeze condition - **See Freeze Alarm**.

The default for *Enabled Freeze Alarm* is No.

Flash For Alarm

You may enter one unit number that will flash on and off continuously when the alarm is activated. This should be an outside light to alert neighbors and police to your property if the alarm is activated.

The default *Flash For Alarm* is Unit 2. You may enter one number for the unit number you wish to have flash, or '0' for none.

House Codes 1-16 Format

House Codes 1-16 can be configured to use the Standard (Preset Dim Command), Extended Code (Level Command), Lightolier's Compose Mode, UPB (open transmission format), Lutron's RadioRA transmission format, HAI Lighting (HLC), and Centralite transmission format.

```
HC 1 FORMAT:          5
HAI LIGHTING    #=CHNG ↓
```

To change format for House Code 1, press the '#' key, and then use the arrow keys to scroll through the list of formats. Press the '#' key to select the desired format. After selecting, press the down-arrow key to change format for the next House Code.

FORMAT	NUMBER	DESCRIPTION
STANDARD	0	Preset Dim Command (X-10, X-10 Pro, Leviton, PCS, etc.)
EXTENDED	1	Extended Code Level Command (Leviton)
COMPOSE	2	Compose Mode (Lightolier's Compose)
UPB	3	Universal Powerline Bus (open format)
RADIO RA	4	Lutron RadioRA
HAI LIGHTING	5	HAI Lighting Control (HLC)
CENTRALITE	6	Centralite Lighting

The default setting for HC 1-16 Format is 5 (HLC).

House Codes 1-16 All Off

This feature allows you to choose if House Code 1-16 will respond to the "All Off" command. Press the 0 key to select No and the 1 key to select Yes. After selecting, press the down-arrow key to change this option for the next House Code.

```
HC 1 ALL OFF:        1
0=NO 1=YES          ↓
```

The default setting for *HC 1-4 All Off* is Yes.

Notes:

1. When configured, each House Code will affect 2 rooms of HLC lighting (i.e. HC 1 ALL OFF affects Room 1 and 2).
2. When the House Code is configured as UPB, RadioRA, or Centralite, "House Code All Off" does not affect the state of the installed devices; however, if this setup item is set to "Yes", OmniPro II will change the status of all units on that House Code to "Off" (even though it doesn't explicitly send an All Off command to those units). If the "House Code All Off" setup item is set to "No", OmniPro II will not change the status of units on that House Code.

House Codes 1-16 All On

This feature allows you to choose if House Code 1-16 will respond to the “All On” command. Press the 0 key to select No and the 1 key to select Yes. After selecting, press the down-arrow key to change this option for the next House Code.

```
HC 1 ALL ON:          1
0=NO 1=YES           ↓
```

The default setting for *HC 1-4 All On* is Yes.

Notes:

1. When configured, each House Code will affect 2 rooms of HLC lighting (i.e. HC 1 ALL ON affects Room 1 and 2).
2. When the House Code is configured as UPB, RadioRA, or CentraLite, “House Code All On” does not affect the state of the installed devices; however, if this setup item is set to “Yes”, OmniPro II will change the status of all units on that House Code to “On” (even though it doesn’t explicitly send an All On command to those units). If the “House Code All On” setup item is set to “No”, OmniPro II will not change the status of units on that House Code.

Time Clocks

There are three *Time Clocks* in the system are used to conditionalize programs. They are used solely to define time periods during the week when certain programs should be enabled or disabled to execute.

```
TIME CLOCK 1 ON
TIME CLOCK 1 OFF
```

Specify the on and off times for each *Time Clock* - **See Set Up Codes.**

```
TIME CLOCK 1 ON TIME:
12:00 AM MTWTFSS #=CHNG↑

TIME CLOCK 1 OFF TIME
--          NEVER #=CHNG↑
```

For example, it may be desirable to conditionalize certain programs to execute only during a normal Monday - Friday 9:00 AM - 5:00 PM work week.

The default for *Time Clock 1 ON* is 12:00 AM MTWTFSS, and the default for *Time Clock 1 OFF* is Never, so that *Time Clock 1* is always Enabled.

```
TIME CLOCK 2 ON
TIME CLOCK 2 OFF
```

```
TIME CLOCK 3 ON
TIME CLOCK 3 OFF
```

Time Clocks 2 and 3 is entered into the system and set for time and dates exactly like the settings for *Time Clock 1*.

Latitude, Longitude, and Time Zone

The system automatically calculates the time of sunrise and sunset each day. Sunrise/sunset can be specified as the time a scheduling command is executed, as an enable/disable time, or as a darkness condition on a scheduling command or event button.

To enable the system to properly calculate sunrise and sunset times, you must enter your latitude, location north or south of the equator, longitude, location east or west of the Prime Meridian, and time zone.

These items should be set to the proper values for the location where the OmniPro II is installed. The latitude and longitude for a particular location may be obtained from an almanac or map of the area. These values should be entered to the nearest degree.

The value entered for the time zone is the number of hours difference between local standard time at the OmniPro II location and Greenwich Mean Time. The following values should be used for the standard time zones in North America:

<u>ZONE</u>	<u>NAME</u>
4	ATLANTIC
5	EASTERN
6	CENTRAL
7	MOUNTAIN
8	PACIFIC
9	YUKON
10	ALASKA-HAWAII
11	BERING

The value specified for longitude may be adjusted to correct for areas, such as Nova Scotia, where the local time differs from Greenwich Mean Time by a non-hourly amount. The calculated time of sunrise/sunset will change by four minutes for every degree change in longitude. To cause the calculated sunrise/sunset to occur later, enter a larger value for longitude. Enter a smaller value for longitude to cause the time to occur earlier.

It is not necessary to alter the time zone to compensate for daylight savings time, the OmniPro II will automatically adjust its calculations for sunrise and sunset, and time when daylight savings time begins and ends.

LATITUDE :	30
0-60	↓
LATITUDE N/S :	1
1=NORTH 2=SOUTH	↓
LONGITUDE :	90
0-180	↓
LONGITUDE E/W :	2
1=EAST 2=WEST	↓
TIME ZONE :	6
0-12	↑

Daylight Savings

The OmniPro II automatically calculates the day of daylight savings time each year. It also adjusts the "time of day" each time daylight savings time begins and ends.

To enable the system to properly calculate daylight savings time, a start month, start weekend, end month, and end weekend is set-up at the factory. You may change or disable this function if desired.

DST START MONTH :	4
1-12 0=DISABLE	↓

```

DST START WEEKEND:
FIRST SUNDAY      #=CHNG ↓

DST END MONTH:           10
1-12  0=DISABLE        ↓

DST END WEEKEND:
LAST SUNDAY        #=CHNG ↑

```

Set the value for DST Start and End Months to "0" if Daylight Savings Time does not apply to your region, or to disable this automatic time update feature.

The DST Start and End Weekend takes place on the specified Sunday (1-7) at 2:00 AM.

To change the DST Start or End Weekend, press the '#' key, then use the arrow keys to scroll through the list. Press the '#' key to make the new selection.

NUMBER	DESCRIPTION
1	First Sunday
2	Second Sunday
3	Third Sunday
4	Fourth Sunday
5	Last Sunday
6	Next to Last Sunday
7	Third from Last Sunday

Controller IP Address

The controller's local network IP address is used to identify the OmniPro II controller on the network. To view and assign the controller's local network IP address, from the Set Up menu, press the 6 (MISC) key. Using the down arrow key (↓), scroll to the following menu item:

```

IP ADDRESS
192.168.0.101      ↓

```

The format of the IP address is a 32-bit numeric address written as four numbers separated by periods. An IP address has two components, the network address, and the host address. The first two numbers (e.g. 192.168) represent the Class B network address and must be the same as the first two numbers of your local network. The second two numbers (e.g. 0.101) identify a particular host on the local network and may be assigned at random as long as each device on the local network has a unique address. Each number can be 0 to 255. Enter the 1, 2, or 3 digit number followed by the "#" key to move to the next number. After the 4th number has been entered, press the "#" key to store the IP address.

Controller Port Number

The controller's local network port number identifies the logical channel to the OmniPro II controller. For example, port 80 is used for HTTP traffic; the controller's local network port number is used for Omni-Link traffic. To view and assign the controller's local network port number, from the previous Setup item (IP ADDRESS), press the down arrow key (↓).

```

PORT NUMBER          4369
0-65535              ↓

```

In most installations, the default port number can remain the same. Port numbers range from 0 to 65535. To change the port number, enter the new port number followed by the "#" key to store the port number. Port numbers 0 to 1024 are reserved for designated services and should not be used.

Encryption Key

Encryption and decryption of data between the OmniPro II controller and the connected device is based on the Advanced Encryption Standard (AES) using a 128-bit cryptographic key. A unique encryption key is randomly assigned to each OmniPro II controller at the factory (no records of these keys are kept at the factory). It may be left the same (recommended) or it may be changed as desired. To view and assign the encryption key, from the previous Setup item (PORT NUMBER), press the down arrow key (↓).

```
ENCRYPTION KEY PT 1 :  
6F-1B-26-A2-FF-D9-E4-12↑
```

This key consists of 16 bytes (that is 16 2-digit values from 0-9 and/or the letters A-F). It is entered into the controller in two parts (PT 1 and PT 2) consisting of 8 bytes each. Enter the 2 digit value. To enter the digits A-F, first press the "OFF" key, then press the 0-5 key respectively (i.e. A1 = OFF 0 1 and CB = OFF 2 OFF 1). After the last digit (16th digit) has been entered, press the "#" key to store "PT 1" of the encryption key. Press the down arrow key (↓) to enter "PT 2" of the encryption key.

```
ENCRYPTION KEY PT 2 :  
DC-67-48-8F-D1-3A-EF-70↑
```

After the last digit (16th digit) has been entered, press the "#" key to store "PT 2" of the encryption key.

Set Up Names

The system can be set up to display descriptive names such as "FRONT DOOR", "JOHN'S BEDROOM", or "PORCH LIGHT" for zones, units, buttons, codes, temperatures, areas, and messages. These names are displayed instead of the unit, zone, button, code, temperature, area, and message number that is normally displayed. Zone and Message names may be up to 15 characters long. Each of the other names may be up to 12 characters long.

To enter the *Set Up Names* menu, from the Setup menu, press the 7 (NAME) key.

```
SET UP NAME  
1=CTRL  2=ZONE  3=BTTN ↓  
  
4=CODE  5=TEMP  6=AREA  
8=MSG           ↑
```

The 6 (AREA) choice will only be displayed if area arming is being used.

Select the item that you would like to name by pressing one of the keys (1-6, and 8). The current name for the first item (unit, zone, button, code, temperature, area, and message) is then displayed. Use the arrow keys to scroll through the list of names.

To enter a name, enter the two digit code shown in Appendix B for each character in the name, then press the '#' key. Use the up arrow key to delete the most recently entered character.

```
ZONE 1 :  
00-95                                     ↓  
  
ZONE 1 :  FRONT DOOR-----  
00-95                                     ↑=DEL  
  
ZONE 1 :  FRONT DOOR  
00-95                                     ↓
```

Set Up Voice

The OmniPro II can be set up to speak descriptive names such as "FRONT DOOR" for control zones, units, buttons, codes, temperatures, areas, and messages. These names will be spoken over the telephone along with the item number that is normally spoken. Voice descriptions for messages can be spoken over a speaker when used with a Two-Way Audio Module.

To enter the *Set Up Voice* menu, from the Setup menu, press the 8 (VOICE) key.

```
SET UP VOICE
1=CTRL  2=ZONE  3=BTTN  ↓
4=CODE  5=TEMP  6=AREA
8=MSG    ↑
```

Select the item that you would like to give a voice description. Use the arrow keys to scroll through the list of names.

To enter a voice description, enter the code shown next to the voice description in Appendix C for each description (word or group of words), then press the '#' key. After you have entered the complete description for each item (unit, zone, button, code, temperature, area, and message), press the '#' key twice. You may enter up to six (6) descriptions (word or group of words) for each unit, zone, button, code, temperature, area, and message.

```
UNIT 1 VOICE:
                                     ↓
UNIT 1 VOICE:
144 109                             ↓
```

When Unit 1 is spoken over the phone, the OmniPro II will say, "UNIT 1 - PORCH LIGHT".

Set Up Address

The final setup item is accomplished over the telephone. This is the address that the system says when it dials out in an emergency. Your voice will be recorded on computer chips in the OmniPro II controller and saved to be played back in the emergency message when the system dials out for an alarm.

Pick up an inside phone and press the '#' key on the telephone within 5 seconds of picking up the phone. The OmniPro II will respond with a menu. Press 8 on the telephone keypad, then 8. The unit will say "ADDRESS IS:" then the OmniPro II will play back the message stored in the Address memory if one has been entered by your installer.

To record your address, Press 9, then enter the Master Code. The OmniPro II will say "RECORD ADDRESS", then BEEP. In a normal tone of voice, say your name and address and any helpful information for locating your house.

"THE JONES RESIDENCE, 1234 JOHNSON STREET, CORNER OF JOHNSON AND THIRD STREET"

The unit will beep after 8 seconds, then play the address back to you. If you are not happy with the sound, re-record by pressing 9 and the Master Code. If you would like to hear the address again, press 8 for Play Address.

If you accidentally press 9 but have not entered your master code and do not wish to record a new address, simply hang up the phone. The address can be recorded from a local (in house) phone or a remote phone. We suggest using a local phone for higher sound quality.

- When the OmniPro II says "record address - beep" any previous address recorded on your system is erased. Always verify that you have your name and address in your system if you have entered this function.
- When recording the address, do not press any touch-tone keys on your phone until the second beep, indicating that recording is complete. This will cause improper operation when the system dials out. The OmniPro II will think that the tone is a code being entered by the called party and it will stop talking.

UNDERWRITER'S LABORATORIES REQUIREMENTS

For a complete list of requirements and restrictions when installing the OmniPro II panel in a UL Listed system, refer to the Underwriter's Laboratories Requirements section of the Installation Manual (10I00-2).

When used in UL Listed Installations, the following items apply:

1. The "High Security Mode" must be ON.
2. The "Enable Auto Bypass" feature must be OFF.
3. The ENTRY DELAY shall not exceed 45 seconds for residential applications; 60 seconds for commercial applications.
4. The EXIT DELAY shall not exceed 60 seconds.
5. Double Delay and Quad Delay zone types shall not be used.
6. For residential applications the sounding device may be mounted indoors. If, however, the sounding device is connected to the "EXT HORN" terminals of the OmniPro II, then the "OUTSIDE SIREN DELAY" shall be set to 0.
7. The DIAL OUT DELAY shall not exceed 30 seconds.
8. The BEEP ON TROUBLE feature must be ON, and CONSOLE SOUNDER must be ON.

Installer:

NAME: _____

NUMBER: _____

FIRE ESCAPE PLANNING

Your fire protection system is designed to provide warning in the event of a fire. It is your responsibility to plan your escape routes in the event of a fire alarm. Your family should practice "fire drills" periodically to ensure that everyone is familiar with the plan.

1. Draw a floor plan of your home, showing location of fire and smoke detectors. Show two exit routes from each room: The primary exit and an alternate escape route.
2. Be sure that your family knows what the fire alarm signal sounds like.
3. In the event of a fire alarm, DO NOT open a closed door. First, touch the door. If it is hot to the touch, use the alternative escape route.
4. Since smoke tends to rise, keep low to the floor during your escape, crawling if necessary. If you encounter any smoke, hold your breath.
5. During a fire alarm, do not stop to pack or gather belongings. Exit immediately and meet at a designated spot outside the house.
6. DO NOT return to a burning house.
7. Notify the fire department using a neighbor's telephone.
8. Review your escape plan and rehearse a fire alarm periodically with your family.

FEDERAL COMMUNICATION COMMISSION NOTICE:

1. This equipment complies with Part 68 of FCC Rules. On the door, inside of the OmniPro II enclosure, is a label that contains, among other information, the FCC registration number and Ringer Equivalence Number (REN) for this equipment. If requested, provide this information to your telephone company.
2. An FCC compliant telephone cord and modular plug is provided with this equipment. This equipment is designed to be connected to the telephone network or premises wiring using a compliant modular jack which is Part 68 compliant. See installation instructions for details.
3. The REN is useful to determine the quantity of devices you may connect to your telephone line and still have those devices ring when your number is called. In most, but not all areas, the sum of RENs of all devices should not exceed five (5). To be certain of the number of devices you may connect to your line, as determined by the REN, you should call your telephone company to determine the maximum REN for your calling area.
4. If your OmniPro II system causes harm to the telephone network, the telephone company may disconnect you service temporarily. If possible, they will notify you in advance. You will be advised of your right to file a complaint with the FCC.
5. Your telephone company may make changes in it's technical operations, facilities, equipment, or procedures; if such changes affect the compatibility or use of this device, the telephone company is required to give adequate notice of changes so as to give you an opportunity to maintain uninterrupted service.
6. In the event of equipment malfunction, all repairs should be made by our company or an authorized agent. It is the responsibility of users requiring service to report the need for service to our Company or to one of our authorized agents.

Service can be obtained at:

HAI
21487 Bayou Ct.
Abita Springs, LA. 70420-3151

7. This equipment may not be used on coin service provided by the telephone company. Connection to party lines is subject to state tariffs. (Contact your state public utility commission or CORPORATION commission for information.)
8. This equipment generates and uses radio frequency energy and if not installed and used properly, that is, in strict accordance with the manufacturer's instructions, may cause interference to radio and television reception. This device complies with Part 15 of the FCC Rules. Operation is subject to the following two conditions:
 1. This device may not cause harmful interference, and
 2. This device must accept any interference, including interference that may cause undesired operation.

Part 15 of FCC Rules are designed to provide reasonable protection against such interference in a residential installation. However, there is no guarantee that interference will not occur in a particular installation. If this equipment does cause interference to radio or television reception, the user is encouraged to try to correct the interference by one or more of the following measures:

1. Reorient the receiving antenna.
2. Plug the receiver into a different outlet. If necessary, the user should consult the dealer or an experienced radio/television technician for additional suggestions.

CANADIAN INDUSTRY CANADA NOTICE

Notice: The Industry Canada label identifies certified equipment. This certification means that the equipment meets certain telecommunications network protective, operational and safety requirements. The Industry Canada does not guarantee the equipment will operate to the user's satisfaction.

Before installing this equipment, users should ensure that it is permissible to be connected to the facilities of the local telecommunications company. The equipment must also be installed using an acceptable method of connection. In some cases, the company's inside wiring associated with a single line individual service may be extended by means of a certified connector assembly (telephone extension cord). The customer should be aware that compliance with the above conditions may not prevent degradation of service in some situations.

Repairs to certified equipment should be made by an authorized Canadian maintenance facility designated by the supplier. **Any repairs or alterations made by the user to this equipment, or equipment malfunctions, may give the telecommunications company cause to request the user to disconnect the equipment.**

Users should ensure for their own protection that the electrical ground connections of the power utility, telephone lines and internal metallic water pipe system, if present, are connected together. This precaution may be particularly important in rural areas.

Caution: Users should not attempt to make such connections themselves, but should contact the appropriate electric inspection authority, or electrician, as appropriate.

Notice: The **Ringer Equivalence Number** (REN) assigned to each terminal device provides an indication of the maximum number of terminals allowed to be connected to a telephone interface. The termination on an interface may consist of any combination of devices subject only to the requirement that the sum of the Ringer Equivalence Numbers of all the devices does not exceed 5.

This digital apparatus does not exceed the Class B limits for radio noise emissions from digital apparatus set out in the Radio Interference Regulations of the Canadian Department of Communications.

Le present appareil numerique n'emet pas de bruits radioelectriques depassant les limites applicables aux appareils numeriques de la class B prescrites dans le Reglement sur le brouillage radioelectrique edicte par le ministere des Communications du Canada.

IF YOU HAVE TROUBLE WITH YOUR PHONES

...and you suspect that your OmniPro II is causing the trouble, disconnect the Controller from the phone lines by removing the PHONE LINE cable from BOTH THE PROCESSOR BOARD AND THE RJ31X JACK INSIDE THE CONTROLLER ENCLOSURE.

APPENDIX A - DIAL OUT PLANNER

Use the following dial-out planner to help you set-up the voice dial-out numbers:

OmniPro II Voice Dial-Out Planner

DIAL OUT NUMBER 1: _____ AREA: _____

DIAL OUT 1 ON: TIME: _____ DAYS: _____

DIAL OUT 1 OFF: TIME: _____ DAYS: _____

DIAL OUT NUMBER 2: _____ AREA: _____

DIAL OUT 2 ON: TIME: _____ DAYS: _____

DIAL OUT 2 OFF: TIME: _____ DAYS: _____

DIAL OUT NUMBER 3: _____ AREA: _____

DIAL OUT 3 ON: TIME: _____ DAYS: _____

DIAL OUT 3 OFF: TIME: _____ DAYS: _____

DIAL OUT NUMBER 4: _____ AREA: _____

DIAL OUT 4 ON: TIME: _____ DAYS: _____

DIAL OUT 4 OFF: TIME: _____ DAYS: _____

DIAL OUT NUMBER 5: _____ AREA: _____

DIAL OUT 5 ON: TIME: _____ DAYS: _____

DIAL OUT 5 OFF: TIME: _____ DAYS: _____

DIAL OUT NUMBER 6: _____ AREA: _____

DIAL OUT 6 ON: TIME: _____ DAYS: _____

DIAL OUT 6 OFF: TIME: _____ DAYS: _____

DIAL OUT NUMBER 7: _____ AREA: _____

DIAL OUT 7 ON: TIME: _____ DAYS: _____

DIAL OUT 7 OFF: TIME: _____ DAYS: _____

DIAL OUT NUMBER 8: _____ AREA: _____

DIAL OUT 8 ON: TIME: _____ DAYS: _____

DIAL OUT 8 OFF: TIME: _____ DAYS: _____

INSTRUCTIONS TO CALLED PARTY

Dear _____

I have programmed my OmniPro II Home Automation system to call you if my alarm is activated. If it is activated, it will call and say: "Emergency... Emergency... The (burglar or fire) alarm has been activated at the following address:

Phone Number _____ Please respond immediately."

This message will be repeated 2 times.

*At any time during the message, please dial my code, which is: _____
(If you make a mistake, press # then enter the code again.)*

This will stop the system from making any further calls. The system will tell you what zone caused the alarm.

Press 9. The system will say "Good-bye" and hang up.

Hang up, then call me at: _____ If no one answers, please hang up, then call the police, fire, or emergency departments.

NOTE: IF THE SYSTEM SAYS "THIS IS A SILENT ALARM", please call the police immediately and tell them that a silent alarm has been activated at my address!

Thank you very much. _____

HOME PHONE: _____ OFFICE PHONE: _____

APPENDIX B - TEXT DESCRIPTION CHARACTER CODES

CODE	CHAR	CODE	CHAR	CODE	CHAR	CODE	CHAR
00	SPACE	24	8	48	P	72	h
01	!	25	9	49	Q	73	i
02	"	26	:	50	R	74	j
03	#	27	;	51	S	75	k
04	\$	28	<	52	T	76	l
05	%	29	=	53	U	77	m
06	&	30	>	54	V	78	n
07	'	31	?	55	W	79	o
08	(32	@	56	X	80	p
09)	33	A	57	Y	81	q
10	*	34	B	58	Z	82	r
11	+	35	C	59	[83	s
12	,	36	D	60	¥	84	t
13	-	37	E	61]	85	u
14	.	38	F	62	^	86	v
15	/	39	G	63	_	87	w
16	0	40	H	64	`	88	x
17	1	41	I	65	a	89	y
18	2	42	J	66	b	90	z
19	3	43	K	67	c	91	-
20	4	44	L	68	d	92	×
21	5	45	M	69	e	93	-
22	6	46	N	70	f	94	à
23	7	47	O	71	g	95	ß

APPENDIX C - VOICE DESCRIPTION CODES

<u>CODE</u>	<u>DESCRIPTION</u>	<u>CODE</u>	<u>DESCRIPTION</u>	<u>CODE</u>	<u>DESCRIPTION</u>
255	(ADDRESS MSG)	286	BOAT	318	DANGER
58	(BEEP)	200	BOILER	61	DATE
254	(MEMO MESSAGE)	287	BOTTOM	62	DAY
29	(PAUSE)	288	BOUDOIR	319	DEAD
30	(SHORT PAUSE)	47	BOY'S	320	DECEMBER
26	A. M.	201	BREAK	208	DECK
256	ABOVE	289	BREAKFAST	321	DECREASE
31	AC POWER	48	BRIGHTER	63	DEGREES
32	ACCESS	49	BUILDING	64	DELAYED
257	ACTIVE	50	BURGLAR	65	DEN
33	ADDRESS	51	BUTTON	66	DENIED
258	AFTERNOON	52	BYPASS	209	DESK
259	AIR	290	CABINET	322	DETECTED
34	ALARM	291	CABLE	210	DETECTOR
260	ALERT	292	CALL	323	DEVICE
35	ALL	202	CAMERA	324	DIAL
198	ALLEY	53	CANCEL	325	DIGIT
261	AMPLIFIER	293	CANS	67	DIMMER
262	AND	294	CARPORT	68	DINING
263	ANNIVERSARY	203	CASE	326	DISABLE
264	ANTIQUE	204	CCTV	327	DISARMED
195	APARTMENT	295	CD	211	DOCK
36	APPLIANCE	205	CEILING	328	DOG
265	APPROACHING	296	CELLAR	69	DOOR
266	APRIL	54	CENTER	70	DOWN
37	AREA	297	CENTRAL	330	DRAPES
267	ARMED	206	CHANDELIER	212	DRAWER
199	ART	298	CHANGE	331	DRESSING
268	ASLEEP	196	CHECK	71	DRIVEWAY
269	ASSISTANCE	299	CHILDREN'S	72	DURESS
270	AT	300	CHRISTMAS	332	DVD
271	ATRIUM	301	CIRCUIT	73	EAST
38	ATTIC	302	CLASS	333	ECONOMY
272	AUDIO	303	CLOSE	22	EIGHT
273	AUGUST	304	CLOSED	8	EIGHTEEN
39	AUTO	55	CLOSET	23	EIGHTY
274	AUTOMATIC	56	CODE	334	ELEVATOR
275	AUTOMATION	305	COFFEE	1	ELEVEN
40	AUXILIARY	306	COLD	74	EMERGENCY
276	AWAKE	307	COMFORT	335	ENABLE
41	AWAY	308	COMMUNICATOR	75	ENERGY
277	BABY'S	309	COMPANY	76	ENTER
42	BACK	194	COMPUTER	336	ENTERING
278	BANK	310	CONSOLE	337	ENTERTAINMENT
279	BAR	207	CONTACT	77	ENTRY
280	BARN	57	CONTINUE	193	EQUIPMENT
43	BASEMENT	59	CONTROL	338	EVENING
44	BATH	60	COOL	78	EVENTS
45	BATTERY	311	CORNER	213	EXECUTIVE
281	BAY	312	COUNTER	339	EXERCISE
46	BED	313	CRAFT	79	EXIT
282	BELL	314	CRITICAL	340	EXTENSION
283	BILL	315	CURRENT	214	EXTERIOR
284	BIRTHDAY	316	CURTAIN	215	FACTORY
285	BOARD	317	DAMPER	216	FAILURE

<u>CODE</u>	<u>DESCRIPTION</u>	<u>CODE</u>	<u>DESCRIPTION</u>	<u>CODE</u>	<u>DESCRIPTION</u>
341	FALL	369	HELLO	408	LOWER
80	FAMILY	370	HELP	231	MACHINE
81	FAN	98	HIGH	409	MAID'S
342	FATHER'S	371	HIGHER	410	MAIL
343	FAULT	372	HOBBY	113	MAIN
344	FEBRUARY	99	HOLD	411	MANAGEMENT
217	FENCE	373	HOLIDAY	412	MANAGER
5	FIFTEEN	374	HOME	413	MARCH
17	FIFTY	375	HOT	114	MASTER
218	FILE	100	HOURS	414	MAT
345	FILTER	376	HOUSE	415	MAY
82	FIRE	377	HUMIDITY	416	MECHANICAL
219	FIRST	101	HUNDRED	115	MEDICAL
16	FIVE	378	IMMEDIATELY	417	MEDICATION
346	FLAG	379	IN	418	MEETING
347	FLOOD	380	INCREASE	419	MENU
220	FLOOR	225	INFRARED	197	MESSAGE
221	FLOW	381	INPUT	420	METER
348	FORCE	226	INSIDE	421	MID
15	FORTY	102	INSTANT	422	MIDDLE
349	FOUNDATION	103	INTERIOR	423	MIDNIGHT
350	FOUNTAIN	382	INTERNET	116	MINUS
14	FOUR	227	INTRUSION	117	MINUTES
4	FOURTEEN	104	INVALID	424	MOBILE
83	FOYER	105	IS	118	MODE
84	FREEZE	383	JACUZZI	425	MODEM
351	FREEZER	384	JANUARY	426	MODULE
352	FRIDAY	385	JEWELRY	427	MONDAY
353	FROM	386	JULY	232	MONITOR
85	FRONT	387	JUNE	428	MONTH
354	FULL	388	KEEPER	429	MORNING
355	FUNCTION	389	KENNEL	430	MOTHER'S
222	FURNACE	390	KEY	119	MOTION
86	FUSE	106	KITCHEN	431	MOVIE
223	GALLERY	228	LAMP	432	MUD
356	GAME	391	LANAI	433	MUSIC
87	GARAGE	392	LAND	434	MUTE
357	GARDEN	393	LANDSCAPE	435	NANNY
88	GAS	394	LASER DISK	436	NEXT
224	GATE	395	LAST	120	NIGHT
89	GIRL'S	396	LAUNCH	24	NINE
90	GLASS	397	LAUNDRY	9	NINETEEN
358	GO	398	LAWN	25	NINETY
92	GO TO	399	LEAK	437	NO
359	GOOD	400	LEAVE	438	NOOK
91	GOOD-BYE	107	LEFT	439	NOON
360	GOT	108	LEVEL	121	NORTH
361	GREAT	401	LIBRARY	122	NOT
362	GROUNDS	402	LIFT	440	NOVEMBER
363	GROUP	109	LIGHT	123	NOW
364	GUARD	403	LIGHTING	124	NUMBER
93	GUEST	404	LIGHTS	125	NURSERY
94	GUN	110	LISTEN	441	NURSE'S
365	GYM	405	LIVE	442	O'CLOCK
95	HAD	111	LIVING	443	OCTOBER
96	HALL	229	LOADING	126	OFF
366	HAPPY	406	LOBBY	127	OFFICE
367	HARBOR	230	LOCK	128	OH
368	HAVE	407	LOFT	129	ON
97	HEAT	112	LOW	130	ONE

<u>CODE</u>	<u>DESCRIPTION</u>	<u>CODE</u>	<u>DESCRIPTION</u>	<u>CODE</u>	<u>DESCRIPTION</u>
444	ONLINE	153	RIGHT	245	STORE
445	ONLY	154	RISE	504	STUDIO
233	OPEN	477	ROMANTIC	505	STUDY
446	OPTION	237	ROOF	506	SUITE
131	OR	155	ROOM	507	SUMMER
447	OTHER	478	RUN	508	SUMP
448	OUT	238	SAFE	171	SUN
132	OUTDOOR	479	SAFETY	509	SUNDAY
133	OUTLET	239	SATELLITE	510	SWITCH
449	OUTSIDE	480	SATURDAY	172	SYSTEM OK
450	OVER	481	SAUNA	511	TABLE
234	OVERFLOW	156	SAVER	173	TALK
235	OVERHEAD	482	SCENE	174	TAMPER
27	P. M.	483	SCHOOL	512	TAPE
134	PANIC	484	SCREEN	513	TEEN
451	PANTRY	240	SECOND	246	TELLER
452	PARKING	157	SECONDS	175	TEMPERATURE
453	PARLOR	158	SECURE	514	TEMPORARY
454	PARTY	159	SECURITY	176	TEN
135	PATIO	485	SEND	515	TENANT
455	PAUSE	241	SENSOR	516	THANK YOU
136	PC	486	SEPTEMBER	517	THEATER
137	PERIMETER	487	SERVICE	177	THEN
456	PERSONNEL	488	SET	178	THERMOSTAT
457	PET	160	SETTING	247	THIRD
138	PHONE	20	SEVEN	3	THIRTEEN
458	PHRASE	7	SEVENTEEN	13	THIRTY
459	PIER	21	SEVENTY	12	THREE
460	PLACE	489	SEWING	518	THURSDAY
461	PLANTS	490	SHADES	179	TIME
139	PLAY	491	SHED	180	TIMED
140	PLEASE CHOOSE	492	SHOCK	519	TIMER
462	PLUS	161	SHOP	181	TO
141	POINT	493	SHOW	520	TOOL
142	POLICE	494	SHUTTERS	521	TOP
143	POOL	162	SIDE	522	TOUCHSCREEN
144	PORCH	163	SILENT	523	TRACK
463	POSITION	18	SIX	524	TRANSMITTER
464	POT	6	SIXTEEN	248	TRAP
145	POUND	19	SIXTY	525	TRASH
465	PRECIOUS	495	SKYLIGHT	526	TREE
146	PRESS	496	SLIDING	183	TRIPPED
466	PRESSURE	497	SMART	182	TROUBLE
467	PROGRAM	242	SMOKE	527	TUB
468	PROTECTED	498	SNOW	528	TUESDAY
147	PUMP	164	SOUTH	529	TUNER
469	QUARTERS	165	SPA	530	TV
470	RAIN	499	SPARE	2	TWELVE
471	RAISE	500	SPOT	11	TWENTY
472	READING	501	SPRING	10	TWO
148	READY	243	SPRINKLER	531	TYPE
236	REAR	502	STABLE	532	UNDER
149	RECORD	166	STAIRS	184	UNIT
473	RECREATION	503	STAIRWELL	185	UP
474	RECYCLE	167	STAR	533	UPPER
150	REMOTE	244	STATION	534	USER
151	REPEAT	168	STATUS	192	UTILITY
475	RESIDENCE	169	STEPS	186	VACATION
152	RESTORE	191	STOCK	249	VALVE
476	RESTRICTED	170	STORAGE	535	VANITY

<u>CODE</u>	<u>DESCRIPTION</u>	<u>CODE</u>	<u>DESCRIPTION</u>	<u>CODE</u>	<u>DESCRIPTION</u>
250	VAULT	605	PHRASE 5	633	PHRASE 33 (1&2)
536	VCR	606	PHRASE 6	634	PHRASE 34 (3&4)
537	VIDEO	607	PHRASE 7	635	PHRASE 35 (5&6)
538	VISITOR	608	PHRASE 8	636	PHRASE 36 (7&8)
539	VOLUME	609	PHRASE 9	637	PHRASE 37 (9&10)
540	WAITING	610	PHRASE 10	638	PHRASE 38 (11&12)
541	WALK	611	PHRASE 11	639	PHRASE 39 (13&14)
542	WALKWAY	612	PHRASE 12	640	PHRASE 40 (15&16)
251	WAREHOUSE	613	PHRASE 13	641	PHRASE 41 (17&18)
543	WARNING	614	PHRASE 14	642	PHRASE 42 (19&20)
187	WATER	615	PHRASE 15	643	PHRASE 43 (21&22)
544	WEDNESDAY	616	PHRASE 16	644	PHRASE 44 (23&24)
28	WELCOME TO OMNI	617	PHRASE 17	645	PHRASE 45 (25&26)
545	WELCOME	618	PHRASE 18	646	PHRASE 46 (27&28)
188	WEST	619	PHRASE 19	647	PHRASE 47 (29&30)
189	WINDOW	620	PHRASE 20	648	PHRASE 48 (31&32)
546	WINE	621	PHRASE 21	649	PHRASE 49 (1-4)
252	WING	622	PHRASE 22	650	PHRASE 50 (5-8)
547	WINTER	623	PHRASE 23	651	PHRASE 51 (8-12)
548	WOOD	624	PHRASE 24	652	PHRASE 52 (13-16)
549	WORK	625	PHRASE 25	653	PHRASE 53 (17-20)
253	YARD	626	PHRASE 26	654	PHRASE 54 (20-24)
550	YOU	627	PHRASE 27	655	PHRASE 55 (25-28)
190	ZONE	628	PHRASE 28	656	PHRASE 56 (29-32)
601	PHRASE 1	629	PHRASE 29	657	PHRASE 57 (1-8)
602	PHRASE 2	630	PHRASE 30	658	PHRASE 58 (9-16)
603	PHRASE 3	631	PHRASE 31	659	PHRASE 59 (17-24)
604	PHRASE 4	632	PHRASE 32	660	PHRASE 60 (25-32)

NOTES ON CUSTOM PHRASES

When you can't find a word that you need to complete a voice description or voice message, you have to ability to record a custom phrase in OmniPro II. This phrase can then be used as part of your voice description and spoken over the telephone along with the item number that is normally spoken. It can also be part of your voice descriptions for a message that is spoken over a speaker in your home or business. There is enough memory in OmniPro II for 64 seconds of voice data.

Phrases 1-32 are unique two-second phrases.

Phrases 33-48 are four-second phrases that are made up of 2 two-second phrases. If you have a need for a voice description or voice message to be longer than the two-second allotment for Phrases 1-32, then Phrases 33-48 can be used to simulate a four-second phrase. For example, when you record Phrase 33 (which is a four-second phrase), the voice data is actually stored in Phrase 1 and Phrase 2. In this case, Phrase 1 and Phrase 2 are probably unusable individually because the first half of the voice data for Phrase 33 is stored in Phrase 1 and the second half is stored in Phrase 2.

Phrases 49-56 are eight-second phrases that are made up of 4 two-second phrases. For example, when you record Phrase 49 (which is an eight-second phrase), the voice data is stored in Phrases 1-4. In this case, Phrases 1-4 are probably unusable individually because the voice data for Phrase 49 is divided up and stored in those phrase locations.

Phrases 57-60 are sixteen-second phrases that are made up of 8 two-second phrases. For example, when you record Phrase 57 (which is a sixteen-second phrase), the voice data is actually stored in Phrases 1-8. In this case, Phrases 1-8 are probably unusable individually because the voice data for Phrase 57 is divided up and stored in those phrase location.

NOTE TO INSTALLER

Following installation, this manual shall be left for the homeowner's use.



HAI • New Orleans, LA • U S A